

AVANT[®]

e513 e527

Operator's Manual 2024-

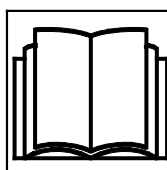

Read this Operator's Manual, safety decals, and other safety related instructions before operating the loader. If you do not obey these instructions, there is a risk of serious injury. Keep all manuals for reference.

TABLE OF CONTENTS

INTRODUCTION	3	Cabs (option)	73
Foreword	3	OPERATING INSTRUCTIONS	76
Make sure all relevant manuals are available.....	4	Starting the loader	77
Intended use	5	Emergency stop button.....	78
Avant warranty	8	Stopping the loader (Safe stopping procedure).....	79
SAFETY FIRST	9	Drive control.....	80
General safety instructions.....	9	Operation in cold conditions	83
Handling of heavy loads	13	Steering of the loader.....	84
Operation on uneven surfaces, gradients, and near excavations	14	Material handling.....	85
Personal safety and protective equipment.....	16	In case the loader tips over	86
Electric systems of the loader and battery pack - Safety	19	WORKING WITH ATTACHMENTS	87
DESCRIPTION OF THE LOADER	24	Requirements for attachments	87
Identification of the loader	24	Coupling the attachments	89
Main parts of the loader	26	Connecting the hydraulic hoses of the attachment.....	91
Signs and decals	27	Using the auxiliary hydraulics.....	92
Technical specifications	36	Releasing the residual pressure of hydraulic system.....	93
Tyres.....	38	Coupling adapters	94
Auxiliary hydraulics oil flow	41	STORAGE, TRANSPORT, TIE DOWN POINTS AND LIFTING	96
LIFT CAPACITY	43	Storage	99
Rated operating capacity.....	45	Lifting of the loader	100
Tipping load - Load diagram	48	BATTERY AND CHARGING	102
CONTROLS AND OPTIONS OF THE LOADER	50	Charging the battery.....	105
Overview of controls.....	51	SERVICE AND MAINTENANCE	112
Dashboard.....	53	Installing of service support and frame lock.....	115
Multi-function display	54	Daily inspections and periodic service schedule	116
Control of loader boom, auxiliary hydraulics and other functions	59	Daily maintenance and inspections.....	117
Boom floating (option)	64	Daily and weekly maintenance.....	119
Smooth drive (option)	65	Inspections after starting the loader	126
Counterweights.....	66	Periodic service.....	127
Extra auxiliary hydraulics outlets, front and rear (option).....	69	Electric system & fuses	133
Seat - Seat belt and seat adjustments.....	70	Auxiliary power and jump start.....	135
Lights	71	TROUBLESHOOTING	138
		MAINTENANCE LOG	141
		INDEX	144

Introduction

Foreword

AVANT TECNO OY wants to thank you for purchasing this battery powered Avant loader. It represents a new level of quiet operation with no local emissions and low operating costs. The battery powered model range is designed and built upon Avant's long experience with compact loaders and is manufactured in Finland. We ask you that you read and understand the contents of this Operator's Manual completely before operating the loader. This Operator's Manual is intended to help you to:

- operate this machine safely and efficiently
- observe and prevent situations that may cause a risk or danger
- keep the machine in good condition and its life span as long as possible

The following warning symbols are used throughout this Operator's Manual to indicate factors that must be considered to reduce the risk of personal injury or damage to property:

	WARNING: SAFETY ALERT SYMBOL
	This symbol means: “Warning, be alert! Your safety is involved!” This safety symbol refers to important safety information in this Operator's Manual. It warns of an immediate hazard that could cause serious personal injury to yourself or others near the equipment. The safety alert symbol by itself and with related safety statement indicates important safety messages throughout this Operator's Manual. It is used to draw attention to instructions involving your personal safety or the safety of others. When you see this symbol, be alert: Your personal safety is involved. Carefully read the message that follows and inform other operators.

DANGER This signal word indicates a hazardous situation which, if not avoided, will cause death or serious injury.

WARNING This signal word indicates a potentially hazardous situation which, if not avoided, could cause serious injury or death.

CAUTION This signal word is used when minor injury could result if the instructions are not followed properly.

NOTICE

This signal word indicates information about the correct operation and maintenance of the equipment.

Failure to observe the instructions accompanying the symbol can lead to equipment breakdown or other property damage.

Make sure all relevant manuals are available



DANGER

Wrong use of the equipment can cause death or serious injuries - Make sure to read all relevant Operator's Manuals and instructions thoroughly and keep them available for all operators.

Using each attachment requires specific information about correct use, mounting procedure, safety, and how to avoid hazardous situations. An attachment may introduce risks that are not present when operating the loader with other kinds of attachments. Always read the Operator's Manual of each attachment carefully.

Contact your local Avant dealer for any questions, service, spare parts or about any problems that may occur with the operation of your loader or its attachments.

Always keep this Operator's Manual with the loader. If this Operator's Manual gets lost, ask for a new copy from your Avant dealer. Remember also to give this Operator's Manual to the new owner when the loader changes ownership.

Manuals of attachments



DANGER



Attachments can create significant risks that are not covered by this Operator's Manual of the loader.

Make sure you have all attachments manual available. Wrong use of an attachment can cause serious injuries or death.

Each attachment is accompanied by its own respective Operator's Manual. The Operator's Manual will show important information related to safety, and how to attach, use, and maintain each attachment correctly.

Spare parts list



All spare parts of the loader are listed in a separate spare parts list.

Contact your Avant service partner or dealer to order parts. Have the serial number of the loader available when ordering to ensure correct parts.

Connectivity and collection of data

NOTICE

Loader collects and transmits technical data according to the terms of the user agreement. Read and understand the data collection methods and purposes. By operating the loader you agree that the information is recorded and transmitted by the loader.

The data collection and communication system will store battery and loader related technical data for product development purposes and for diagnostics help. Loader will use cellular network connectivity to transmit data. The data is anonymously stored in servers located within EU. Access to data is available only to authorized employees of Avant Tecno Oy, Finland.

Read the user agreement of the loader for full details of data collection related information of the loaders.

NOTICE

Technical data collection is required for battery diagnostics and to facilitate service. Any attempt to tamper with the IOT system will void warranty of the loader and the battery.

Intended use

The Avant e series loaders are battery powered, hydraulically operated, articulated compact loaders. They are designed and manufactured for both private and professional use. The loader can be equipped with a range of attachments offered by Avant Tecno Oy, which enables you to do several different jobs with the same machine. Because of this multi-purpose nature of the machine and the various attachments and tasks, read always not only this Operator's Manual but also the Operator's Manual of the attachment, and follow all instructions. Every person who deals with this machine must follow work safety regulations, all other generally accepted rules related to work health and safety, and all road traffic regulations.

Remember that safety consists of several factors. The loader, by itself or equipped with an attachment, is very powerful and can cause serious personal injuries or property damages if operated in a wrong or careless way. Never allow the compact size of the loader to distract from this fact and keep it in mind when you consider allowing another user to operate it. Do not operate an attachment unless you have familiarised yourself with the use of it and the eventual dangers and risks related to it. Take the keys with you when you leave the loader unattended to prevent other, unauthorized persons to operate the machine. The loader is not intended to lift or transport people or be used as a work platform. Different jobs require different attachments, and it is not allowed to handle any material or loads without any attachment fitted.

This loader has been designed to need as little maintenance as possible. The operator can perform the routine maintenance operations. There are however more demanding service operations that can be done by professional service personnel only. Wear appropriate protective equipment when you do any service or maintenance work. Original spare parts must be used. Familiarise yourself with the service and maintenance instructions in this Operator's Manual. Operating a loader that is in poor condition, or that has received unauthorised modifications, can be hazardous to the operator and bystanders.

Contact your local Avant dealer, if you are uncertain of anything concerning the operation and maintenance of this loader, or for any questions, service, or spare parts.

In addition to the safety instructions included in this Operator's Manual, you must observe all occupational safety regulations, local laws, and other regulations concerning the use of the equipment. Particularly the regulations concerning the use of the equipment on public road areas must be observed. Contact your Avant dealer for more information about local requirements before you operate the loader on road areas.

Battery operated e513 and e527

The loader is designed to be operated with the battery pack that is supplied with the loader, and approved by the manufacturer. The high-power Lithium-ion technology battery pack is specifically designed and manufactured for this loader model. Any other battery pack must not be used in this loader. The battery pack must not be used for any other purposes than for the Avant e513 or Avant e527 loaders, and must always be used with the electronic protection and safety systems that are built into the battery pack.

The battery pack must be charged only with the internal charger of the loader, or the external charging system supplied by Avant specifically for this loader model. Using any other batteries or chargers can cause risk of fire or damage to the battery and risk of electric shock. Using wrong type of chargers can quickly destroy the battery.

Any modification or damage to the battery can cause risk of fire of the battery. Therefore, you must not ever use a battery that has been damaged or attempt to open the battery. Maintenance tasks that you can do to this electric system without special training and qualification are limited to charging the battery and cleaning the cooling systems and external surfaces of the battery pack.

The battery pack does not have other user serviceable parts and must never be opened. Never connect any device directly to the battery. All fuses that can be replaced are located outside of the battery assembly.

Storage and transport

If possible, transport the loader with a battery charge level below 50 %. The risk of battery fire in case of an accident will be reduced in relation to the energy stored by the battery.

Operating and storage temperatures

The loaders e513 and e527 can be used in a wide ambient temperature range. For the best performance and service life of the lithium-ion battery, the charger must be connected to mains power supply in cold or hot ambient temperatures.

The battery cells are immersed in OptiTemp[®] fluid to control and to balance the temperature of the battery cells. Temperature inside the battery is controlled automatically by the battery management system (BMS). BMS will activate battery heating when the temperature of the battery is low. The BMS will also activate cooling fans in hot ambient temperatures and during charging, when necessary.

Temperature management will use battery power. If the battery is empty and a charger is not connected, heating or cooling is not possible. In this case the battery will not perform as expected, can get damaged, and its service life can be significantly shortened.

Follow the information in this manual regarding recommended temperatures. See page 99 for information regarding the storage of the loader.

NOTICE

When internal temperature of the battery is below 0 °C driving with the loader is not possible, or driving is possible at reduced performance. When battery temperature is between 0 to 10 °C, the performance of the loader is limited to protect the cold battery.

Battery heating is activated when a charger is connected, or the ignition key is switched to ON. Normal operation is possible after the battery has heated itself.

NOTICE

In extreme ambient temperatures (below -20 °C or higher than 40 °C) or if the battery state of charge is <20 %, a charger must be connected and active. This activates charging and also the heating or cooling of the battery as necessary to keep the battery within temperature limits.

Always keep the charger connected to the battery when the ambient temperature is below 0 °C. If the battery does not have enough charge left for automatic cooling or heating functions, the battery cells may get permanently damaged and its performance or charge capacity may decrease significantly.

For optimum lifetime, during storage:

NOTICE

- Keep the state of charge of the battery around 40-50 % ("half full")
- Store the loader at temperatures between 0 °C to 20 °C.

See additional instructions regarding storage and battery in this manual.

Versions of this Operator's Manual

Avant has a policy on continuous product development. Updated versions of the Operator's Manual replace the previous versions of this Operator's Manual as long as the year on the cover page matches with the original Operator's Manual. You can ask for the latest Operator's Manual from your dealer. Some of the features or technical details presented in this Operator's Manual may change without notice. The pictures in this Operator's Manual may show optional equipment or features that are not currently available in your market area. We reserve the right to change the contents of the Operator's Manual without notification.

Keep this manual with the loader



Read this manual before use. Put this manual, as well as manuals of attachments, into the storage box behind driver's seat when you have read those.

Always keep this Operator's Manual with the loader. If this Operator's Manual gets lost or damaged, ask for a new copy from your Avant dealer. Also remember to give this Operator's Manual to the new owner when the machine changes ownership. Ask for the electronic copy of this Operator's Manual from your dealer.

Operator qualification

Only operators who have studied this Operator's Manual, and all relevant attachment manuals, are allowed to use this loader. Regardless of your possible earlier experience with lawnmowers, loaders, ATVs, or other equipment, it is important that you learn the driving principle of this loader. Practice how to operate the loader and its attachments safely at an open area before you use the loader near other persons.

You must be in good physical and mental condition with the ability to stay alert and to observe the surrounding areas. Never use the equipment while under influence of medication which could impair your abilities to operate the equipment safely. Do not operate the loader if you are under the influence of alcohol or any other intoxicant.

Depending on operating area, you may also be required to read, understand, and comply with all applicable Employer, Industry, and Governmental rules, standards, and regulations.

Electric qualification

Operating the loader and regular maintenance tasks shown in this manual do not require specific electricity related qualifications. High-voltage cables and connectors, inverter, and electric motors do not have components that can be serviced by user. Battery does not have components that can be serviced. To replace the battery pack contact Avant service.

Any battery or electric systems related maintenance that is not shown in this manual is prohibited to avoid risks of electric shock, fire and short-circuit.

Availability of options

Some equipment or options that are shown in this Operator's Manual may not be available. Pictures in this Operator's Manual may show optional equipment. Availability of optional equipment is subject to change. Some options may preclude the installation and use of some other option or options. Check with your Avant dealer for more information.

Avant warranty

This warranty specifically applies to the Avant e513/e527 loader only and not to any attachments used with this product. Any repairs or modifications performed without the prior authorisation of Avant Tecno Oy will cancel this warranty. During the first two years of operation or first 1000 hours (whichever is the soonest) Avant Tecno Oy warrants to replace any part or repair any defect which may occur, subject to the terms detailed below:

1. The product has received regular maintenance in accordance with schedules given by the manufacturer.
2. Any damage caused by operation in a negligent manner or exceeding the approved specifications detailed in this Operator's Manual is excluded.
3. Avant Tecno Oy accepts no responsibility for interruption to working or any other consequential losses resulting from any failure of the product.
4. Only Avant Tecno Oy approved replacement or original quality parts shall be used during routine maintenance.
5. Any damage caused using incorrect fuel, lubricants, cooling liquid or cleaning solvents is excluded.
6. The Avant Warranty excludes any consumable parts (e.g. tyres, batteries, filters, belts etc.) except where it can be clearly shown that these parts were defective on original supply.
7. Any damage caused resulting from the use of attachments not approved for use with this product is excluded.
8. In the event a fault occurs which is attributable to manufacturing or assembly defect you should arrange to return your Avant to your authorised dealer for repair. Travel and freight costs are excluded.

Special warranty terms regarding the battery

Battery is warranted for 3 years of use, or 900 charge cycles. At the end of the warranty period the battery capacity should be no less than 70 % of a new battery.

Warranty of the battery is void

- if any seal label is broken
- if data collection of the battery is prevented or otherwise tampered with.

Safety First



DANGER

Incorrect or careless use of the loader can cause a serious accident. Before you operate the loader, familiarise yourself with the correct use of the loader. Read and understand this Operator's Manual, as well as all relevant safety instructions, local regulations, and safe working practices.



Understand the limitations of speed, braking, steering, and stability, as well as load capacity of the loader before starting use. Make sure that everyone who operates or works with this equipment is familiar with these safety precautions.

If you have no previous experience of the loader, make sure to do all testing at a safe and open place, where there are no persons in the area of operation.

General safety instructions

1. When seated, always keep the seat belt fastened and keep hands and feet inside the operator's area.
2. Remember the correct working position. When driving, be comfortably seated on the driver's seat, keep your feet in their proper place in the footwell and at least one hand on the steering wheel.
3. Before leaving driver's seat, always:
 - Lower the loader boom and place attachment flat on ground
 - Engage the parking brake
 - Switch off the loader, remove the ignition key
4. Switch off the loader whenever leaving the driver's seat.
5. Read all instructions related to operating an electric loader, including instructions for charging, operating temperatures, handling of the battery, and maintenance related to battery and electric systems of the loader.
6. Start using the loader slowly and carefully. Practice driving of the loader at a safe and open place before connecting any attachment. Follow the instructions in this Operator's Manual and also the Operator's Manual of the attachment.
7. Operate the control levers with careful and deliberate movements. Avoid abrupt movements when handling a load, to prevent the load from falling and to keep the loader stable.
8. Keep away from the danger zone of the lifted boom and do not let anyone go there.
9. Always read the Operator's Manual of relevant attachments and always keep the manuals available for all users. Read the attachment manuals and follow given instructions.
10. Always stay alert when operating the loader or its attachments. Observe surrounding areas, other people, and ground surface and slopes. Stay alert for abnormal operation of the loader, such as changes in noise or vibration, or other signs of malfunctions.
11. Keep your hands, feet and clothing away from all moving parts, hydraulic components, and hot surfaces.
12. Make sure that there is enough open space around the loader and its attachment for safe driving and operation of the attachment.
13. Some attachments or their parts may reach into the driver's area if used improperly. Always read the operator's manuals of the attachments for possible limitations of use.
14. Do not transport loads with the boom lifted. Always carry all attachments as low as possible. Lower the load or attachment down on the ground before you leave the driver's seat.
15. Never transport persons with this machine. Do not transport or lift persons in the bucket or in any other attachment. Lifting of persons is only allowed with the attachment designed for this purpose: the Avant Leguan 50 access platform, following the instructions in the Operator's Manual of Leguan 50 attachment.

16. Do not exceed the tipping load. Familiarise yourself with and follow the load diagrams and other information in this Operator's Manual.
17. When turning with the machine, remember that the driver's seat extends beyond the turning radius of the wheels (collision risk).
18. Do not operate the loader in an explosive environment, or in a place where dust from work operation or gasses can create a fire or explosion hazard.
19. Keep the areas near the battery, electric motors, other electrical systems and cooling systems clean of combustible materials. Materials such as dirt, hay or dust create a risk of fire on hot surfaces.
20. Read the lifting, towing, and transportation instructions on page 96.
21. Follow all inspection, service, and maintenance instructions. If you notice any faults or damages on the machine, these must be repaired before starting operation.
22. Before any maintenance or repair operation always switch off the loader, lower the boom down and release pressure from hydraulic system. Allow the loader to cool. Read safety instructions for maintenance on page 112.
23. Do not let anyone who has not read and understood all safety instructions, and who is not familiar with the safe and correct use of this loader, to operate this loader or its attachments.
24. Never operate the loader or attachments while under the influence of alcohol, drugs, medication that may impair judgment or cause drowsiness, or if not otherwise medically fit to operate the equipment.



Risk of crushing under boom or attachment - Stay away from lifted boom and attachment.

Always remember that load can fall and the boom can lower unexpectedly due to loss of stability, mechanical fault, or if another person operates the controls of the loader, leading to crushing hazard. Lower the boom or any attachment or load on the ground before leaving the driver's seat. The attachment or the loader are not intended to be left to keep a load elevated for longer periods. The stability of the loader can change when leaving the driver's seat, leading to tipping over of the machine. Do not allow anyone to get under or near a lifted boom or attachment.



Safety devices are installed for your safety - Never modify or bypass any safety function.

Safety functions are installed for your safety. Never modify or block any of the safety systems of the loader. If you notice that a system is not in good condition, stop the use of the loader and make sure the loader is serviced.



DANGER



Hydraulic pressure - Risk of serious injury. Hydraulic hoses and other hydraulic components may have trapped pressure to cause leaking hydraulic oil to penetrate skin. Never use hands to search for possible leaks in hydraulic systems - use a piece of cardboard instead. Release residual hydraulic pressure before searching for leaks, before disconnecting any fitting, and before any service operation. Seek medical attention immediately if hydraulic fluid penetrates skin, serious injury can develop quickly even with mild initial symptoms.



WARNING



Risk of falling from height and getting overrun by loader - Never lift or transport other people. Never use the loader or its attachments to lift or carry persons, or as any kind of work platform even temporarily. Never climb on the loader or on the attachment. Seating capacity of the loader: one person only, regardless of attachments.



WARNING



Risk of serious injury or death from falling objects. Never tilt the attachment back when it is lifted high. Operate only with machines equipped with ROPS and FOPS structures. Secure loads on attachments if loads can fall. Use correct type of attachments for different loads and follow Operator's Manuals of attachments.



WARNING



Risk of being crushed by moving loader - Engage parking brake before leaving the driver's seat. Follow safe stopping procedure to prevent all movements of the loader. Avoid leaving the loader parked on hill. If it is necessary to park on a hill, use chocks or other additional means to prevent the loader from moving.



WARNING



Pinching points - Avoid getting hands or feet crushed between the front and rear frames of the loader, or between loader and walls - Keep all body parts within the safety frame. Movements of the articulated frame creates pinching hazards. Keep your head, hands, and feet inside the loader. Be especially careful while you drive near walls and trees. Keep your hands on steering wheel and joystick.



**Risk of crushing between tyres -
Do not turn the steering wheel
while standing near the loader.**

Turning the articulated frame creates a pinching hazard to a person standing near the tyres of the loader. Never grab the steering wheel while entering or leaving the driver's seat to avoid turning of the frame. Stop the loader if other persons get close to the machine. Check that tyres that are larger than standard tyres leave enough space between the tyres for safe use.

Battery safety

The loader is equipped with a high power Lithium-Ion battery pack. There are no user serviceable components in the battery or the electric system of the loader, other than those specified in this manual.

Always follow correct charging procedure and instructions concerning safety of charging.

Always read this operator's manual.



**Hazards of fire, electric shock,
and release of toxic chemicals -
Read instructions about correct
use of the battery and the
electric loader.** This manual includes instructions for safe and correct use of the loader. All maintenance tasks that can be made by user are listed in this manual. Other maintenance and service must be left for service professionals. Incorrect handling or damaged battery cause risk of fire and electric shock. Burning of battery causes potential exposure to toxic chemicals.

Seat belt



**Always wear seat belt when
using the loader. The seat belt
will keep you inside the ROPS
area in case the loader tips over.**

If you do not wear the seat belt, there is a risk of getting crushed between the ROPS and ground in case the loader tips over. See more information about seat adjustments and seat belt on page 70.

Hazardous areas around the loader

Make sure that there are no persons in the danger zone of the loader or the attachment. The safe distance to other persons depends on the attachment that is mounted on the loader, and the type of work. The danger zone of the loader covers the reach area of the loader boom, the turning area and wheels on both sides of the loader, and the front and rear areas of the loader. Stop the loader and its attachment immediately if there are other persons close to the loader.

Always make sure that it is safe to reverse with the loader. Never assume that bystanders will remain where you last saw them; especially children are often attracted to the moving equipment.

Pay attention to other machines and persons that are moving in the area. When learning how to operate the loader, drive on level ground at a clear, open area.

When you leave the loader unattended, always follow the safe stopping procedure that is described in this Operator's Manual. In particular, always lower the loader boom completely down, or lower the attachment on the ground. The loader is not designed to stay with the loader boom and load lifted. Remove the key from the ignition to prevent unauthorised use.



Risk of fire and explosion - Never operate the loader in explosive atmospheres. The loader is not certified to be used in places where there is dust, gasses, chemicals, or other substances, which can get ignited by sparks or hot surfaces.

Handling of heavy loads



Handle heavy loads and attachments with care - Risk of tipping over.



- Follow all instructions and warning labels to avoid tipping over of the loader.
- Always lower the load or attachment down on the ground before you leave the driver's seat.
- Keep loads as low and as close to the loader as possible.
- Never take a heavy load on the loader from high level – e.g. from truck, shelf etc.
- When loading, always keep the loader frame as straight as possible. If you turn the loader during load handling, the stability of the loader will decrease, and it may overturn the machine.
- The use of extra rear weights or ballasted tyres is recommended. See pages 66 and for different options.
- Make sure to follow the recommended tyre pressures and pay attention to the condition of tyres.
- When you estimate the lifting capacity of the loader, remember to take the weight of the attachment into account.

Whenever you handle heavy loads or heavy attachments:

- Always handle heavy loads only on firm, level ground while you drive slowly with the loader.
 - Uneven or inclined terrain significantly reduces the Rated operating capacity (see also page 43).
 - Use the maximum loads indicated in the load chart on the loader and in this Operator's Manual as a guideline.
 - All rated operating capacities are based on the criteria that the loader is level on firm ground. When the loader is operated in conditions that deviate from these criteria (e.g. on soft or uneven ground, on a slope, or when subject to slide loads), you must take these conditions into account.
 - Remember that the actual load carrying capacity varies greatly according to operating conditions and control manner.
- Keep in mind that a heavy load or long distance between the loader and the centre of gravity of the load will affect the balance and handling of the loader.



DO NOT drive with any load lifted

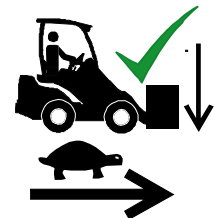

ALWAYS keep loads as close to the ground and as close to the loader as possible while driving

ALWAYS drive slow while carrying loads



Risk of overturning - Articulated frame. Turning articulated frame can lead to overturning of the loader on inclined terrain or when driving at high speed. Never turn frame towards the slope while operating on inclined ground.

Always drive slowly when carrying load or when turning with the loader.



Risk of overturning - Sudden movements can tip the machine over. Movements, such as stopping, turning, or lowering the boom abruptly, can cause loss of stability. Always drive slowly and operate the controls of the loader very carefully, especially when handling heavy loads.

Operation on uneven surfaces, gradients, and near excavations



Uneven ground can cause the loader to overturn - Risk of serious injury or death. The stability and the load handling capacity of the loader are significantly reduced on inclined terrains and maximum lifting capacity can be achieved only on firm, level ground. On horizontally tilted terrain the load must be kept close to the ground and must never be lifted high.

Handle heavy loads only on even surfaces.

On uneven ground:

Extra caution is needed when using the equipment on inclined terrains and slopes. Drive slowly especially on inclined, uneven, or slippery surfaces, and avoid sudden changes in speed or direction. Operate the controls of the loader with careful and smooth movements. Watch out for ditches, holes on the ground, and other obstacles, as hitting an obstacle may cause the loader to tip over.

All rated operating capacities are based on the criteria that the loader is level on firm ground. When the loader is operated in conditions that deviate from these criteria (e.g. on soft or uneven ground, on a slope, or when subject to slide loads), you must take these conditions into account.

**WARNING**

Risk of tipping over on uneven ground - Drive slow on inclined surfaces. Always keep loads close to the ground. Keep the seat belt fastened to stay within the Roll over protective structure. Always handle heavy loads or only on firm, level ground while you drive slowly with the loader.

- Uneven or inclined terrain significantly reduces the Rated operating capacity (see also page 43). Remember that the actual load carrying capacity varies greatly according to operating conditions and control manner.
- Use the maximum loads indicated in the load chart on the loader and in this Operator's Manual as a guideline.
- Keep the articulated frame of the loader in straight position when driving on inclined surfaces. If you turn the loader on an inclined surface, the stability of the loader will decrease in both forward and sideways directions, and may cause the loader to tip over.
- The use of extra side weights or ballasted tyres is recommended. See pages 66 and for different options.

Whenever you operate the loader on uneven ground keep the following in mind:

- Handle heavy loads only on even surfaces. Lifting a load or turning on uneven surfaces can cause the loader to tip over.
- Do not drive on a too steep gradient - watch out for ditches, manholes and steep slopes, which may cause the loader to tip over.
- On steep slopes drive straight up or down, not across the slope. Keep the heavier end of the loader towards downhill - When driving with a load or heavy attachment, keep the load downhill and close to the ground, and reverse the hill up.
- Never drive along an excavation. Note that the excavation or trench may suddenly cave in. Exercise extreme caution when driving near ditches or embankments, and avoid driving along a ditch or trench, as the machine could suddenly tip over if an edge caves in. Avoid driving along trenches and keep at least a distance equal to width of a trench.
- Do not park the loader on a slope. If this cannot be avoided, engage the parking brake, preferably park the loader across the slope and lower the load or attachment onto the ground. If needed, use wheel blocks. Always engage the parking brake.

Personal safety and protective equipment

Wear safe clothing and personal protective equipment.

- Protect yourself against work hazards like noise, ejecting debris or dust for example.
- Follow regulations regarding protective equipment. Wear eye protection and hard hat or other protective equipment as needed.
- Read Operator's Manual of the attachment for more information about protective equipment needed in the work.



- The noise level at the driver's seat may exceed 85 dB(A), depending on the attachment and type of work. Wear hearing protection while working with the loader.



- Wear protective gloves.



- Wear safety boots whenever working with the loader.



- Wear safety glasses when handling hydraulic components and during maintenance or service work.

Depending on the installed attachment and type of work, safety glasses may be needed while using the loader.



- Always fasten seat belt while operating the machine.



- When working at construction sites, a safety helmet is recommended and may be mandatory in addition to the falling objects protective structure (FOPS) on the loader.



- Depending on work and working area, also a respirator mask or other breathing air filtering apparatus may be required. Find out about other necessary safety equipment at your specific work site.



Stay within the space protected by the ROPS safety frame. Always keep seat belt on to stay on driver's seat and to avoid getting crushed between ground and a loader that tips over.



Silica dust warning. Prolonged or repeated exposure to crystalline silica can cause serious or fatal respiratory disease. Occupational health and safety officials recommend limiting exposure to dust that is present at most earth-moving and many other work sites. Avoid spreading of dust where possible, keep loader cab clean from dust, and use respiration mask when necessary.

Safety frame (ROPS) and safety canopy (FOPS)

The loader is equipped with a Rolling Over Protective Structure (ROPS) and a Falling Object Protective Structure (FOPS). These safety structures are important parts of operator safety, and they must be fitted on the machine.

Safety frame (ROPS) protects the operator in case the machine tips over. Fasten seat belt while operating a machine with a ROPS. All cab versions are ROPS & FOPS tested and certified.



WARNING



Crushing hazard - Always keep safety structures installed. Never remove the safety structures, modify them, or attempt to repair. If damaged, contact service.

Always fasten the seat belt in order to stay inside the protected area of the safety frame. If you do not wear seat belt you may become crushed under the ROPS or other structure of the loader in case the loader tips over.

Falling objects protection system (FOPS)

The loader is equipped with a Level 1 Falling Object Protective Structure (FOPS), which gives protection against moderate impacts from objects falling from above. Understand the limitations of the Level 1 FOPS. Your work environment may have specific risks related to falling objects and the level of protection that is needed to reduce the risk. Use of the loader with FOPS level 1 may be prohibited in the work area.

Modifications

Any modification to this machine must be approved beforehand by an authorised Avant representative. If you modify the loader or attachment, it can become dangerous and cause serious injuries or even death. Unauthorised modifications can increase the risk of accidents and damage or shorten the service life of the machine. Modifications to electric systems can create serious risks of electric shock, fire, and damage or explosion of the battery. Modifications or incorrect repairs can also make the loader no longer compliant with regulations concerning electromagnetic emissions. Use only original spare parts to make sure that the product is kept in safe operating condition.

Working near powerlines

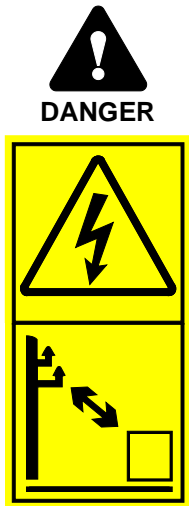

Electrocution hazard - Stay away from electric cables. Contact with or working too close to electric wires can cause a lethal electric shock. Keep the loader and any attachment at a sufficient distance from all electric cables, see the table below. Never assume a cable is disconnected.

Table 1 - Safety distance from powerlines

Use this table for minimum safety distances for electric cables, if other information is not available.

Voltage level	Safety distance, minimum
0 - 1000 V	2 m
1 - 45 kV	3 m
110 kV	4 m
220 kV -	5 m
Unknown voltage	5 m

In case of inadvertent contact or proximity with live electric source, or if electric cables are exposed during digging:

- Do not leave the loader until the electricity has been disconnected by qualified technicians, usually by the local electric company.
- If absolutely necessary, jump out from the loader, keeping feet next to each other, and continue jumping away from the loader until at a safe distance.
- Warn others not to approach the loader until it is safe to do so.

Safety of digging



Risk of serious injury or death - Plan all digging work ahead. Accidental or intended contact with electric cables, gas pipes, telecommunications cables, water mains, or other structures buried in ground can cause serious injuries and be fatal. Contact local authorities before starting to dig.

Digging may expose buried electric cables, and some attachments may make it possible to reach overhead powerlines with the loader, creating hazard of electric shock and electrocution.

Plan work ahead and take necessary safety precautions.

Deeper excavations may cave in. Depending on various factors, such as the type of the soil, moisture content, rainwater, steepness of the excavation, the excavation can collapse and bury in people. Contact local authorities or surveying companies for information about how to reduce the risk of caving in of excavations.

Keep in mind that all pipes might not be marked correctly. Contact local surveying companies for searching of potential hazards in ground whenever in doubt.

Contact local authorities before digging

At some areas you may be obligated to contact relevant authorities before digging ground. Some areas have a direct telephone line or information on a website where you can find more information about possible hazards in the ground. Find out about your local regulations before digging.

Damaging any electric or communications cables, gas or water pipes, or similar structures buried in the ground can put you in risk of serious injury or even death. Damages while digging can cause also significant property damages. As the operator of the equipment, you are responsible for the safety of any digging work and you may be responsible for any damages caused by digging.

Electric systems of the loader and battery pack - Safety

**WARNING**

Risks of electric shock or violent fire of the battery - Handle the battery with care. The loader is fitted with a high-energy lithium-ion battery pack that can output hazardous, even lethal levels of electric current and voltage. Misuse of the battery, or using a damaged battery system, creates a risk of violent burning of the battery, and hazardous electric shock. Follow the instructions regarding charging process, correct types of chargers, use, and maintenance of the battery pack and the electric systems of the loader in this manual.

Electric systems of the loader

The e513 and e527 loaders use a lithium-ion battery pack to power the electric motors of the loader. The battery pack is a complete assembly that operates only as a full system. The battery pack includes the lithium-ion cells which are immersed in a thermal control fluid. The battery pack also includes the Battery Management System (BMS) and other control electronics to ensure reliable and safe operation of the battery.

The battery pack is a sealed system that must never be opened, modified, or used in other way that is shown in this manual. Any repair must be left for Avant service.

The energy from the battery pack is used in two parallel systems:

1. High voltage supply (nominal voltage 44 V) from the battery is converted by an inverter to a high-voltage and high-current electric power to drive the electric motors of the loader.
2. A 12 V DC converter supplies electricity to the control systems of the loader, hydraulic valves, dashboard, electric socket etc.

Never attempt to open modify the high voltage system or connect any device directly to it. This system can output high current that can kill or cause electric shock and burns, if handled carelessly or if safety systems are bypassed.

NOTICE

As an option, the loader can be equipped with an additional, small 12 V battery to power attachments that have electric functions, and the road traffic light kit. If installed, the 12 V battery is always on. The battery is located at the rear frame on the left side of the loader.

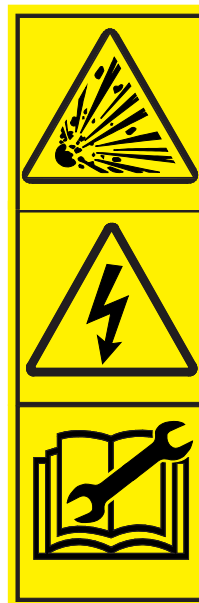
**DANGER**

Misuse, damage, or short-circuit of the battery can cause the battery to burn violently - Never attempt to open or disassemble the battery pack. Disconnect battery before maintenance.

Use only the original Avant chargers to charge the battery. The battery must never be opened.

Isolate the battery from the electric systems of the loader by removing the ignition key before working on the electric systems of the loader. Check that all cables and insulator sleeves and caps are in good condition and that metal conductors are not exposed.

Handle battery with care

The battery pack consists of the main components shown in the following image.

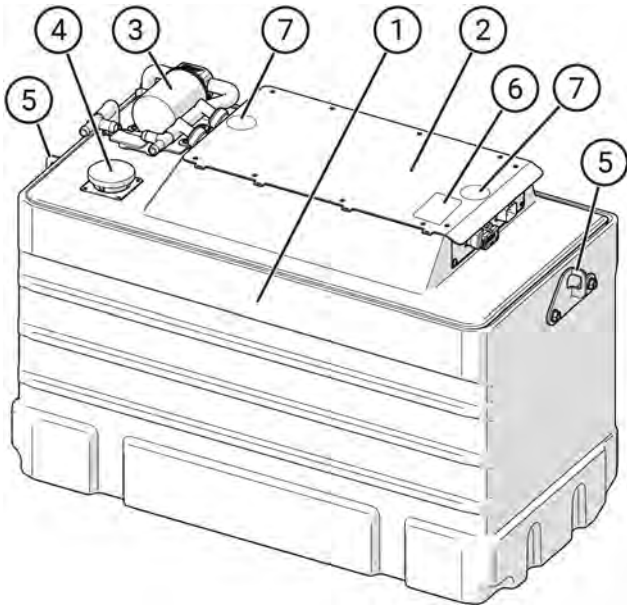

1. Battery pack housing
2. Battery management system (BMS)
3. Pump unit
4. Battery fluid cap
5. Lifting lugs on both sides of the battery pack (see page 135)
6. Label: Safety of battery
7. Label (2 pcs): Battery seal.

Always keep in mind the following general instructions related to the Lithium-ion battery:

- The battery pack is a sealed system that has no user serviceable parts. Service is allowed by trained personnel only.
 - Never attempt to open the battery assembly or fluid cap.
 - Never remove the battery from the loader.
 - Never connect or disconnect cables of the battery, or other electric systems of the loader.
 - All repair and service not shown in this operator's manual must be left for qualified Avant service.
- Use only chargers that are specified for this loader. Do not use a damaged charger or damaged charging cables. Follow instructions of the charger.

- Observe the correct temperatures regarding charge, storage, and use of the loader. See page 5 for more information.
- Use the battery only for its intended application. Other use of the battery is prohibited.
- Do not expose battery to
 - excessive mechanical stress
 - hot environment (>60 °C)
 - static electricity
- For thermal control, the battery is filled with a OptiTemp® fluid. The system does not require checks or maintenance. Never open the fluid cap on the battery. If the seal on the cap is removed or damaged, the warranty of the battery is void.
- If any fuse on the loader is blown repeatedly, find out the cause. Always use fuses with correct rating. There are no replaceable fuses or electronics inside the battery pack assembly.
 - If access to fuses, electric motors, or other electric parts of the loader is necessary, make sure the the ignition key is not in the key switch to prevent the battery from getting activated.
- Battery cells contain electrolyte which is corrosive and flammable. Burning electrolyte creates toxic fumes.
 - If the battery is damaged, or there is visual damage on the battery housing, stop using the loader and park the loader outdoors to a safe location. A damaged battery can start to burn spontaneously even after a long time after an accident.

Used batteries must be treated as hazardous waste. They must be disposed of properly, see page 136.

**WARNING**

Lithium-ion battery, risk of fire and electric shock - Never attempt to open the battery assembly. Damaged battery, extreme heat, improper charging procedure, or other type of wrong use can cause the battery to burn violently.

Never use a damaged battery. If the battery has been involved in collision, dropping from height, or if an external object has pressed against the battery housing, park the loader outdoors to an open area away from buildings. Battery fire can start after a long time.

There are no user serviceable parts inside the battery pack assembly. Never attempt to open the battery assembly or to repair any battery related part.

**WARNING**

Hazards of electric shock and exposure to leaking thermal fluid in case battery is dropped - Never remove or install the battery yourself. Battery can be lifted only from its lifting points using appropriate types of lifting equipment. Always contact authorized Avant service personnel if battery must be replaced.

Fire prevention

To minimise the risk of fire, keep the loader clean and follow the instructions in this manual. Always follow the following general fire safety instructions:

- Follow maintenance instructions. Keep the loader clean and check the general condition of the loader as recommended. Check the condition and installation of electric cables.
- Always keep the loader clean to avoid build-up of flammable, combustible debris, such as dust, leaves, hay, straw, etc. See page 119 for more instructions about cleaning of the loader.
- Keep all coolers, cooling fans, and cooling surfaces clean.
- Never operate the loader if there is a leak from the battery. The battery must be filled with the thermal fluid specified by Avant. Never open the battery thermal fluid cap.
- There are many parts on the electric system of the loader that operate at high temperatures during normal use. To avoid risk of fire, and to ensure that the cooling of all electric and battery related systems is ensured, keep the loader clean. Overheating of electric parts can shorten their service life, or even cause fire.
- Add hydraulic oil only at a well ventilated place.
- Oil leaks can ignite on hot components. Repair any damaged or leaking components before using the loader.

Know where fire extinguishing equipment is located near your working site. At some areas a fire extinguisher may be mandatory. Keep a multi-purpose, approved type fire extinguisher available near the place where you store the loader.

Avoid driving at areas with open fire or significant sources of heat. The battery housing is designed to resist temperatures of up to 80 °C



WARNING

Fire risk - Battery cells contain flammable liquid electrolyte, which is harmful and in large quantities toxic. Avoid any contact with leaking electrolyte. In case of fire, battery electrolyte may release toxic gasses. Leaking electrolyte reacts with moisture and forms hydrogen fluoride gas, which is very acidic and toxic.



WARNING

Risk of rupture of battery housing, fire, and release of harmful gasses - Check the battery immediately after loader is involved in an accident. The battery is partially protected by the frame of the loader and is able to withstand collisions or other damage that may result from operating the loader at its maximum driving speed. However, long or protruding objects, such as fork lift arms, can penetrate the battery pack in a collision, causing leaking of thermal fluid, and creating a battery fire hazard. Always have the loader and battery inspected if the loader is subjected to collisions, impacts, or any load or stress that is not typical for a loader.



WARNING

Risk of fire and electric shock - Discontinue use and prevent fire immediately if battery or its housing is visually damaged. A damaged battery can ignite by itself later. If the battery is visibly damaged, or damage is suspected after an impact or other type of accident, if possible, park the loader to an open area, away from buildings, cars, or other property. Do this regardless of visible smoke or other signs of fire. Monitor the loader for at least 24 hours, then contact Avant service for battery replacement.

In case of fire



CAUTION

Fire risk due to damaged battery - Mechanically damaged or partially burnt battery must not be left unattended. Battery may self-ignite due to the chemical properties of lithium-ion batteries.

Know where fire extinguishing equipment is located at your working site. At some areas a fire extinguisher may be mandatory. Keep a multi-purpose, approved type fire extinguisher available near the place where you store the loader.

Use a general purpose fire extinguisher or plenty of water to put out a fire. A fire extinguisher meeting the requirements of EN 3 Class ABC, or similar type of fire extinguisher, delivering equal or higher performance, is recommended.

It is important to be prepared and to extinguish a fire as soon as possible after noticing the fire. The battery cells contain flammable substances, and creates toxic fumes when burning.

In case of fire or smoke

First move all people away from the machine. If possible, move the machine to a location where it is safe to leave it. Do not inhale smoke. Call fire department. Use fire extinguishers and water whenever appropriate and possible.

Fire extinguishing

In case it is safe to approach burning machine (meaning that inhaling smoke can be avoided, and temperature and wind conditions are safe to approach burning object), use a general-purpose fire extinguisher (such as EN 3 Class ABC) and plenty water to put the fire out.

If the fire has reached the lithium-ion battery cells, it is difficult to put out the fire. Use plenty of water to cool and to contain a burning battery, if inhaling or other exposure to fumes can be avoided. Whenever possible, move a burning machine outdoors. Due to the chemical properties of lithium-ion batteries that are damaged or partially burnt, a battery is able to self-ignite again after even several hours. Always inform fire department that the machine is fitted with a lithium-ion battery.



Breathing toxic fumes from fire can be fatal - Keep away from burning loader. Learn how to respond to fire in advance. If the loader is exposed to fire, hazardous substances from the battery can be released, resulting in a risk of battery fire and/or harmful gas emissions.

In case of an accident

In case the battery is subjected to an impact or the battery case gets damaged, if possible, park the loader outdoors, away from buildings and other vehicles. A lithium-ion battery can self-ignite if the battery cells have been damaged. Especially if the thermal fluid in the battery starts to leak, there is a real risk of battery fire. Keep the damaged machine under watch and contact fire department.



Risk of release of toxic gasses - Never expose leaking electrolyte to water. Water will react with exposed battery electrolyte, which will release toxic gasses. Battery housing is designed to prevent water leaking in when the housing is not damaged. Check visually that the battery housing is not damaged. If there is leak from a damaged battery, wear appropriate personal protective equipment and clean fluid leaks with towels or other absorbent material. Avoid driving at areas where water level can reach the battery.

Battery material information

The following information is for firefighters and for battery recycling purposes.

Battery housing	Polypropylene and polyethylene plastic
Thermal fluid	Avant OptiTemp Fluid. Not classified as flammable but will burn.
Battery cell electrolyte	Organic, corrosive electrolyte. Flammable liquid. Will generate dangerous hydrogen fluoride in case of contact with water.

Description of the loader

Identification of the loader

Write down the identification information of your loader in the following fields. Have this information ready when ordering spare parts.

1. Loader model _____
2. Loader serial number _____
3. Manufacturing week and year _____

Serial number of the loader is printed on the type plate, which also indicates the loader model.

Dealer: _____

Contact information

NOTICE

Write down the serial numbers of your loader and its battery. Have them ready when you communicate with your Avant dealer or Avant service partners. The serial numbers help to identify the correct spare parts for your loader.

Loader identification plate:

Loader identification plate is located near the drive pedals.

Contents of the identification plate:

1. Manufacturer's name and address
2. CE mark
3. Designation of machinery
4. Type code of your loader*
5. Serial number*
6. Model year*
7. Manufacturing week / year*
8. Net installed power*
9. Operating mass*

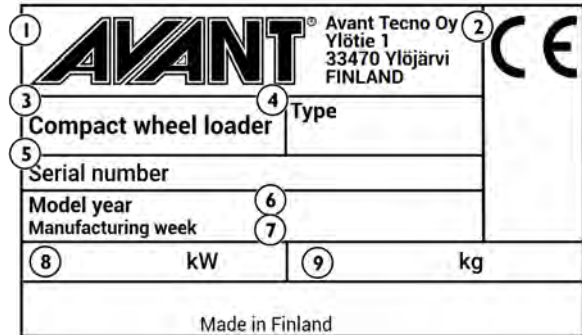

* The labels shown in this Operator's Manual are examples of the labels on loaders. See the identification plates on your loader for detailed information about your specific loader unit. Some loaders that are intended to be used outside of the European Union may not bear the CE mark.

Stamped markings on loader (VIN-number)

If the loader is initially ordered with stamped Vehicle Identification Number (VIN-number), it is located as follows:

Front frame



Rear frame



Battery identification

The battery identification label is located on the battery housing.

For details about the information on the battery see page 38.

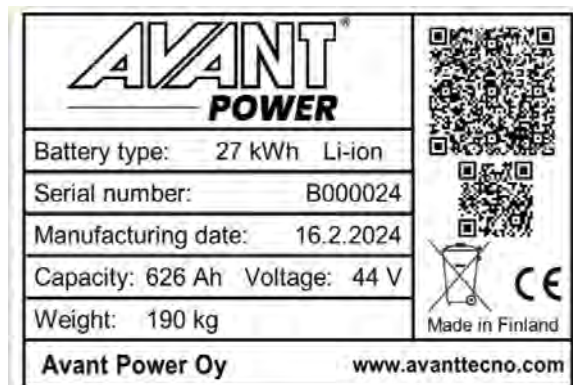

Main parts of the loader

The following picture shows the main parts of the loader. These general parts are the same regardless of the cab type.



1. Front frame

On the front frame are mounted: driver's seat, operating controls, hydraulic control valves, hydraulic oil tank, auxiliary hydraulics outlet, front wheels, hydraulic motors and the loader boom with attachment coupling plate.

2. Back frame

On the back frame are mounted: battery pack, electric motors, integrated charger and its socket, hydraulic pumps, rear wheels, hydraulic motors, parking brake, and counterweights.

Avant Power OptiTemp® Lithium-ion battery pack includes thermal management systems, charging ports and internal charger. For more information about the battery see page 38.

3. Articulation joint

Articulation joint connects the front and back frame. The loader is steered hydraulically by the steering cylinder which is mounted between the front and back frames. Hydraulic hoses and electric wires are conducted through the articulation joint.

4. Loader boom

Loader boom is mounted on the front frame and is controlled with control lever from the driver's seat. The attachment coupling plate is mounted at the end of the boom. The boom is telescopic, extending 600 mm hydraulically. The boom can be fitted with a hydraulic self-levelling system

5. Attachment coupling plate

Attachments are mounted on the attachment coupling plate. The locking pins on the plate can be operated manually (standard) or hydraulically (option).

6. Auxiliary hydraulics outlet

The hydraulic hoses of hydraulically operated attachments are mounted on this outlet. The outlet is equipped with the multi connector quick coupling system and is double acting: it has two pressure lines and one tank line, see page 92.

7. ROPS safety frame

ROPS frame (Roll-over protective structure) complies with the standard ISO 3471:1994 with Amendment 1:1997 and Technical Corrigendum 1:2000 for a maximum machine configuration mass of 2720 kg.

8. FOPS canopy

FOPS canopy (Falling objects protective structure) mounts on the ROPS. It meets the ISO 3449:2005 (1365 J) criteria.

Signs and decals

Shown in the figure below and listed on the following page are the labels and markings, which must be visible on the equipment. Replace any warning label which has become unclear or has detached completely. New labels are available via your retailer or contact information provided on the cover of this Operator's Manual.

Other than safety or warning labels are listed in the separate spare parts catalogue.

To apply a new decal

Before applying a new decal, clean the surface from dirt, dust, grease, or other material. Peel small portion of the decal backing paper and apply exposed adhesive to cleaned surface, aligning the decal properly. Peel rest of backing paper and press firmly with hands or decal application tool to smooth out the decal and to activate the glue of the label.







The warning labels contain important safety information and they help to identify and remember the hazards related to the equipment.

Make sure that the following signs and decals are clean, undamaged and readable. If any of these decals is missing or is unreadable stop using the loader until decal has been replaced. Ask for new decals from your local Avant dealer.





Table 2 - List of safety labels and markings on the machine





Label		
1		<p>Location Panel in front of driver's seat</p> <p>Product code A465711</p>
Symbol		Safety message
a		<p>WARNING</p> <p>a Wrong use, misuse, or careless use can cause hazards that could be prevented with following the instructions properly.</p> <p>Read all instructions carefully before operating the loader.</p> <p>b Lowering of loader boom can crush, causing death or serious injury.</p> <p>Keep out from the danger zone of the machine.</p> <p>c Risks of falling from height and getting run over.</p> <p>Never lift people or carry passengers with the loader or its attachments.</p> <p>d High pressure fluid injection hazard.</p> <p>Never use hands to search for leaks. Use a piece of cardboard and a magnifying glass when searching for leaks.</p> <p>e Risk of dropping of attachment.</p> <p>Make sure both locking pins are locked. Check both locking pins before moving the attachment.</p>
b		
c		
d		
e		
f		

Label		
g		
		<p>f Risk of getting crushed by moving loader. Apply parking brake and lower attachment on the ground. Make sure loader will not move when leaving the driver's seat.</p> <p>g Follow safe stopping procedure and information regarding maintenance and service. Always remove the ignition key from the loader when leaving the loader unattended. Always remove charging cord before starting the loader.</p>
h		h Always wear seat belt.
	i	
		<p>i Wear hearing protection. Noise level at the driver's seat and at the operating area of the loader will reach 88 dB(A) or higher, depending on use and type of attachment. Exposure to noise can damage hearing.</p>
j		j Wear safety boots with good grip and feet protection.
	k	
		<p>k Wear protective gloves which have good grip.</p>

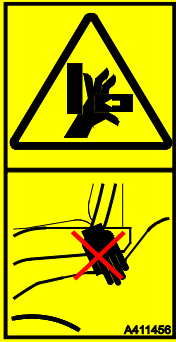
Label	Message
2	<p>On Avant e513</p> <p>Product code A442339</p> <p>CAUTION Stop before using the parking brake. Engaging the parking brake while the machine is moving may cause locking of wheels and sudden stop. Repeated use while driving will damage the hydraulic motors. The parking brake should be used to stop the machine only in emergency.</p>
	<p>Location ROPS Canopy: Near steering wheel On Cab L Only: Above display panel on cab frame</p>

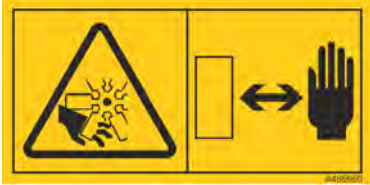
Label			Message	
<p>3</p>			<p>Location Panel near steering wheel</p> <p>Product code A441497</p>	<p>WARNING</p> <p>Risk of tipping over to the side when driving on uneven ground and when driving at high speed, or with heavy load.</p> <ol style="list-style-type: none"> 1. Keep loads close to the ground 2. Drive slowly on uneven ground, and when transporting heavy loads. <p>Always use seat belt</p> <p>If you do not use the seat belt, there is a risk of getting crushed between the ROPS frame and ground in case the loader tips over.</p>
<p>4</p>			<p>Location Panel near steering wheel</p> <p>Product code A465683</p>	<p>WARNING</p> <p>Always follow this safe stopping procedure.</p> <ol style="list-style-type: none"> 1. Release the auxiliary hydraulics control lever to its neutral position. 2. Lower the attachment on the ground. 3. Engage parking brake. 4. Stop the electric motors: <ol style="list-style-type: none"> a) Set pump control lever to idle b) Turn the ignition key left to stop the motors. 5. Release residual pressure of hydraulic circuits. Move control levers to their extreme positions a couple of times. 6. Unfasten seat belt 7. Remove ignition key

Label		Message
5		<p>Location</p> <p>Boom, on both sides</p> <p>Product code</p> <p>A417273 (2 pcs)</p>
6		<p>Location</p> <p>At loader entry point</p> <p>Product code</p> <p>A411455</p>
7		<p>Location</p> <p>Only on loaders ROPS canopy or Cab L</p> <p>At loader entry point</p> <p>Product code</p> <p>A411456</p>

Label		Message
8	 <p>Location Battery compartment, near cooling fans of electric motor compartment.</p> <p>Product code A465950</p>	<p>WARNING Risk of injury to fingers - Cooling fans may start unexpectedly.</p> <p>Cooling fans of battery and electric motors can start automatically. Keep fingers away from fans.</p>
9	 <p>Location Electric motor compartment, on top of motor module.</p> <p>Product code A417270</p>	<p>WARNING Risk of burns - Extremely hot surfaces. Keep clear of hot surfaces.</p> <p>Allow loader to cool completely before maintenance.</p>
10	 <p>Location Battery compartment, on top panel of battery pack (2 pcs).</p> <p>Product code A465941</p>	<p>NOTICE Do not break or remove seal label.</p> <p>Warranty will void if this label is removed.</p>
11	 <p>Location Battery compartment, below charging connectors.</p> <p>Product code A465945</p>	<p>WARNING Risk of electric shock or fire - Read operator's manual.</p> <p>Inadequate mains outlet can cause fire.</p> <p>Use only original Avant external charger for rapid charging. Always stop the external charging before disconnecting the quick charger from the loader.</p>









Label		
12		<p>Location On top panel of battery pack.</p> <p>Product code A466041</p>
Symbol		Safety message
a		<p>WARNING</p> <p>a) Wear protective gloves when handling battery pack.</p> <p>b) Wear eye protection when handling battery pack.</p> <p>c) Do not throw battery pack in mixed waste.</p> <p>d) Serious health hazard. - May damage fertility or the unborn child, cause cancer, allergies or asthma symptoms or damage organs.</p> <p>e) Hazardous to the environment. Toxic to the aquatic life.</p> <p>f) Flammable. - Highly or extremely flammable gas, aerosol, liquid and vapour.</p> <p>g) Health hazard - May cause allergic skin reaction or serious eye irritation. Harm if swallowed or inhaled. Harm to the environment.</p>
b		
c		
d		
e		
f		
g		

Table 4 - Additional decals on loaders equipped with a cab

The following labels are placed to the loader if the loader is equipped with CAB L.

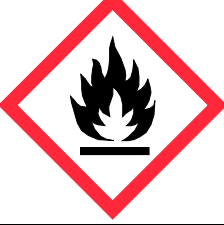

Label		Message
13	 <p>Location On Cab L: Windscreen</p> <p>Product code A420044</p>	<p>EMERGENCY EXIT</p> <p>Use the window hammer to break glass. Make sure the safety hammer is available for emergency use.</p>
14	 <p>Location Only on Cab L: Near right window</p> <p>Product code A411021</p>	<p>EMERGENCY HAMMER</p> <p>Use the hammer to break a glass window panel. On loaders equipped with Cab L the front window (windshield) can be used as an emergency exit when broken with the hammer. Keep in mind that if the side and rear panels are made from polycarbonate, they cannot be broken with the hammer.</p>

Table 5 - Information labels

Label	Message	
<p>15</p> 	<p>ROPS/FOPS Approval, on loaders with ROPS canopy or Cab L</p>	<p>Location ROPS frame, inside</p> <p>Product code A49517</p>
<p>16 ROPS Canopy</p> 	<p>Sound power level 100 dB(A) 2000/14/EC</p> <p>Sound pressure level 88 dB(A) at driver's seat</p>	<p>Location Right panel near driver's seat</p> <p>Product code A465624</p>
<p>17</p> 	<p>Correct type of hydraulic oil See page 127</p>	<p>Location Front panel below driver's seat</p> <p>The original hydraulic oil filled by the manufacturer is shown with one of the following labels.</p> <p>Product codes A446611 A446612</p>
<p>18</p> 	<p>Information about Rated operating capacity. For more information see page 45</p>	<p>Location Roof panel</p> <p>Product code e513: A465254 e527: A464757</p>

Technical specifications

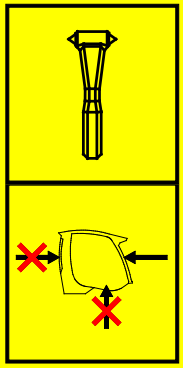
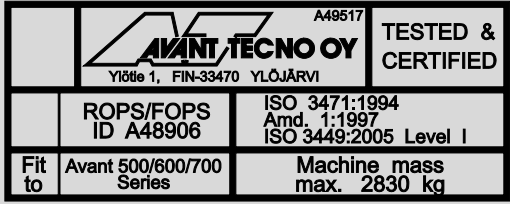
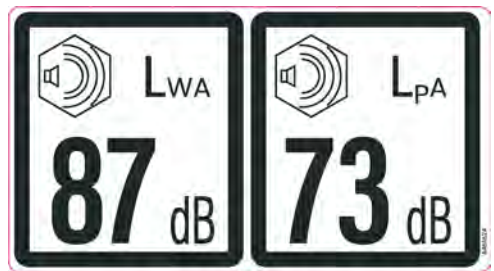
Dimensions

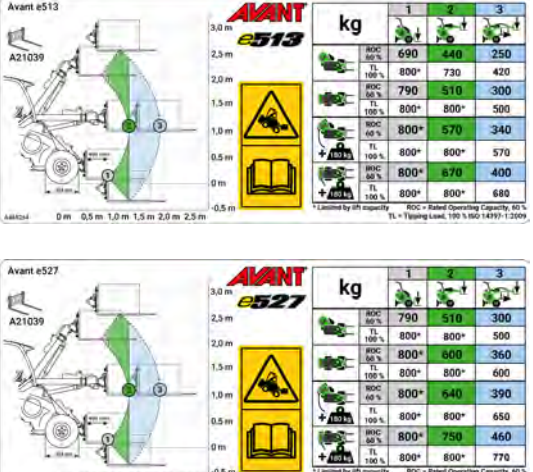
General dimensions	With standard wheels
Length	2610 mm
Width	1130 mm
Height	1980 mm
Mass Operating mass ISO 6016*	e513: 1420 kg e527: 1500 kg
Standard tyres	See page 37
Lifting height, max	2820 mm
Max reach (horizontal)	1690 mm (distance from front axle to quick coupling plate)
Turning radius, inside/outside	995 mm / 2050 mm
Ground clearance	200 mm

* Operating mass (ISO 6016) with ROPS&FOPS canopy. This mass represents the weight of a loader with standard counterweight, typical options, standard tyres, with no attachment fitted, and 75 kg driver on the driver's seat. Additional options or counterweights can increase the mass of the loader. The mass of your specific loader may also be lower.

Height and width

Tyre	Width
27x8.50-15" TR	1030 mm
23x8.50-12" TR/GR	1080 mm
23x10.50-12" TR/GR	1130 mm
26x12.00-12" TR/GR	1290 mm
320/60-12" HD TR	1290 mm
26.5x14.00-12" GR	1420 mm

Height with cab

Tyre	Cab L	Cab GT
27x8.50-15" TR	2048 mm	2100 mm
23x8.50-12" TR/GR	1955 mm	1980 mm
23x10.50-12" TR/GR	1955 mm	1980 mm
26x12.00-12" TR/GR	2035 mm	2070 mm
320/60-12" HD TR	2035 mm	2070 mm
26.5x14.00-12" GR	2035 mm	2070 mm

Tyre types:

- TR** Tractor type tyre tread pattern, with aggressive grooves for best possible traction
- GR** Grass type tyre tread pattern, with smoother surface and larger contact area

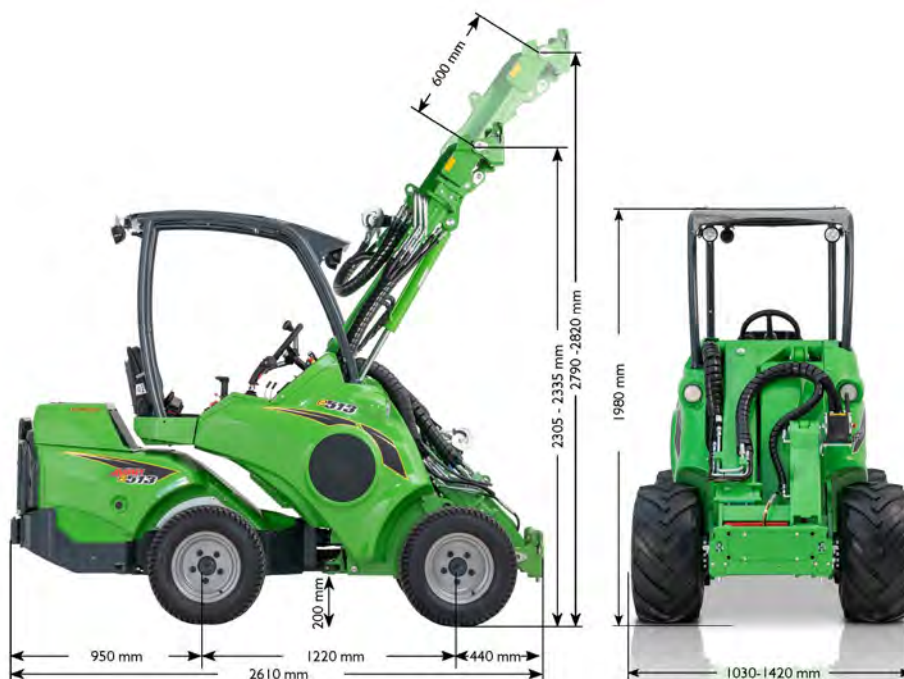

General information

Model	AVANT e513	AVANT e527
Category	Earth-moving machinery / Loader / Compact loader EN ISO 6165	
Drive system	hydrostatic, 1-speed drive motors, 3 electric drive speed ranges	
Lift capacity ISO 14397-1 Load on a pallet, lifted from the ground For more information see page 44	800 kg	
Rated operating capacity	See page 45	
Max. breakout force / 50 cm	1100 kg	
Standard tyres	23x10.50-12" TR or GR	
Battery type	Avant Optitemp 13 kWh Li-ion battery	Avant Optitemp 27 kWh Li-ion battery
Electric motors	2	
Net power	Total: 9,2 kW Hydraulics: 2 kW Drive: 7,2 kW	
Pulling force, static min With standard tyres	950 kp	
Auxiliary hydraulics See also page 41	Max 18,5 MPa (185 bar) Max flow: 34 l/min	
Hydraulic pump	1 auxiliary hydraulic pump	
Auxiliary hydraulics	Standard: Faster multiconnector system on front. Optional: Extra auxiliary hydraulics coupling on front or rear.	
Attachment coupling	Avant quick coupling attachment plate	
Hydraulic oil tank capacity	36 l	
Hydraulic oil type	ISO VG 46, mineral oil only See page 127	
Sound pressure level 2000/14/EC L _{pA} , ISO 6396	73 (A)	
Sound power level 2000/14/EC L _{wA} , ISO 6395	87 dB(A)	
Hand-arm vibration, total	< 2,5 m/s ²	
Whole-body vibration, max.	< 0,5 m/s ²	
Technically permissible maximum masses (With standard tyres)	Front axle: 1415 kg Rear axle: 1415 kg Total: 2830 kg	
Maximum mass of a trailer	1000 kg	

Battery specifications

	e513	e527
Battery type	Avant Power OptiTemp® Lithium-Ion battery pack	
Cell type	21700, NMC	
Battery manufacturer	Avant Power Oy, Finland	
Stored energy (gross)	13 kWh	27 kWh
Mass	120 kg	200 kg
IP Class	54	
Capacity	313 Ah	626 Ah
Voltage	44 V nominal (battery pack) 3,67 V (individual cell)	
Number of modules	2	4
Number of cells	720	1440
Heating and cooling	OptiTemp® Fluid Heating: Electric battery heating as standard Cooling: Cooling package as standard	
Operating temperature	-20 °C...60 °C	
Charging temperature	0 °C...45 °C	
Control system and accessories	12 V / 40 A DC-DC converter Auxiliary 12 V battery (optional), see page 19	
Charging system	Standard: Internal charger, Type 2 plug, 220-240 V / 13 A (3 kW) Optional: 6 kW or 9 kW internal charger, 220-240 V / 13 A, 2 or 3 phase DC rapid charger (optional)	
Charger voltage and current	220-240 V / 13 A x 1-3	

Regulatory information

The battery meets or exceeds the requirements of the regulations and standards listed below.

2006/42/EC	EU Machine directive (EU)
2014/30/EC	Electromagnetic compatibility (EU)
2006/66/EC	Battery Directive (EU)
REACH No 1907/2006 (EU)	Chemical requirements
IEC 62619	Lithium-ion cells
UN 38.3 7th Ed.	Transport of Lithium batteries
IEC 62281	Safety of lithium cells and batteries during transport
IEC 62485-6	Safety requirements for secondary batteries and battery installations in traction applications

Tyres

The loader can be equipped with different type of tyres for different operating conditions. Grass pattern (GR) tyres will damage the ground surface less than tractor (TR) tyres but provide less traction.

The overall diameter of the tyre affects the maximum drive speed pulling force of the loader. Larger tyres increase tyre speed but decrease available pulling force.

All tyres have maximum rating for load capacity and drive speed, or their combination. Inflation pressure of the tyre influences maximum allowed speed of the tyre, or the load carrying capacity. Keep tyre pressures within near recommended pressures.

Use tyre and rim models that are recommended by Avant to ensure that the tyres meet the dimension, load, and speed requirements for this loader model. Replace tyres if there are visible damages on the tyre or rim, or if the wear surface of the tyre has worn, or if there are visible differences between the tyres. Always use the same size of tyres on all wheels.

Tyre options for Avant e513 e527

Tyre	Tread pattern	Code	Fill pressure	Fits with fenders		Fits with snow chains
				Front	Rear	
27x8.50-15"	TR	65414	4,1 bar	-	-	-
23x8.50-12"	GR	65994	4,6 bar	x	x	64455
	TR	65995	2,3 bar	x	x	64455
23x10.50-12"	GR	65996	2,9 bar	x	x	64745
	TR	65997	2,5 bar	x	x	64745
26x12.00-12"	GR	65212	3,4 bar	x	x	64973
	TR	65739	2,1 bar	x	x	64973
320/60-12"	TR	65224	4,0 bar	x	x	65603
26.5x14.00-12"	GR (*)	65787	1,8 bar	x	x	-

(*)Requires 40 mm spacers on the wheel hubs.

Use the widest possible tyres

For the best stability and controllability, always use the widest tyres possible. Tyres that are narrower than the standard tyres are intended for special purposes only with width restriction on the machine.

Use only tyres and rims that meet the original specifications and dimensions to avoid potential issues with load capacity, tyre size, or bearing load on drive motors. Special tyres, such as studded wheels may also be available. Consult your dealer for further information.



WARNING

Risk of tipping over - Make sure tyres are not damaged. Loss of tyre pressure can cause loader to tip over. Make sure there are no visible damages on tyres. Keep tyre pressure within recommendations.

Drive speed and pulling force

	Tyre	Drive speed	Pulling force
e6 TR	23 x 8.50-12" TR	9 km/h	100 %
	23 x 10.50-12" TR	9 km/h	100 %
	26 x 12.00-12" TR	10 km/h	85 %
	320/60-12" HD TR	10 km/h	80 %
	27 x 8.50-15" TR	10 km/h	80 %
e6 GR	23 x 8.50-12" GR	9 km/h	95 %
	23 x 10.50-12" GR	9 km/h	100 %
	26 x 12.00-12" GR	10 km/h	85 %
	26.5 x 14.00-12" GR	11 km/h	75%

Snow chains

There are two types of snow chains. See the tyre table on page 39 for a list of chains that are available for the tyre size of your loader.

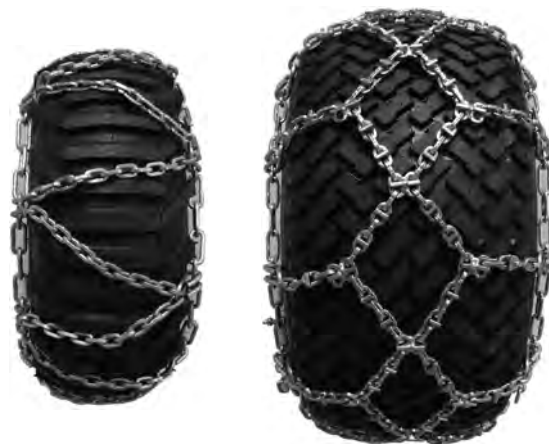

SD

HD

Follow the installation instructions that are provided with the snow chains. Contact service if necessary. Check that snow chains fit without hitting any part of the loader. Check also that the snow tyres will fit when the loader is turned to maximum articulation.

Wheel spacer kit

The wheels can be fitted with spacers that increase the width of the loader for better stability. The wheel spacer kit A418958 includes four 40 mm thick spacers. They must be installed to fit the wide 26.5x14.00-12" tyres.



WARNING

Wheel spacers improve the lateral stability of the loader. Do not remove the wheel spacers unless operating the loader on flat areas, where the total width of the loader must be reduced to as narrow as possible.

NOTICE

Use only spacers recommended by Avant. Too thick spacers may damage the hydraulic motors. Contact your Avant dealer for more information.

Ballasted tyres

Some tyres can be filled with special type of heavy foam that creates additional counterweight. The filled tyres are also useful in area where frequent tyre puncture with normal tyres would be expected.

When driving with a loader that has ballasted tyres, the acceleration and stopping distances may be increased.

Ballasted tyres do not have air pressure inside them and do not require air pressure checks.



Ballasted tyres are heavy - Handle ballasted tyres with care. Filling of tyres should be left to professional tyre service.

When the loader is equipped with ballasted tyres, the following label must be applied to both sides of the loader near articulation joint. If you replace the tyres with normal tyres, make sure to remove this label.

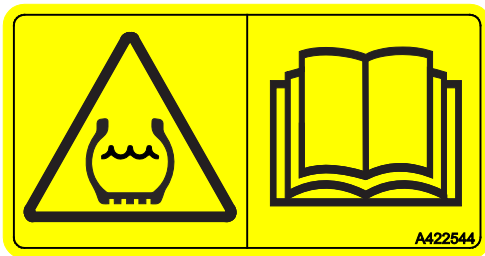

Auxiliary hydraulics oil flow

The following graph shows auxiliary hydraulics output flow at different pump rpm levels. The pump rpm is controlled by the lever, see page 60.

Some attachments work optimally at certain flow level. See operator's manual of the attachment and the multi-function display of the loader to set the correct oil flow.

NOTICE

Lever for pump RPM controls only the auxiliary hydraulic pump. **The position of the lever does not affect the speed or pushing power of the drive system.**

Keep the RPM setting as low as possible to smoothly operate the attachment to conserve energy. Pull the lever back when not operating an attachment.

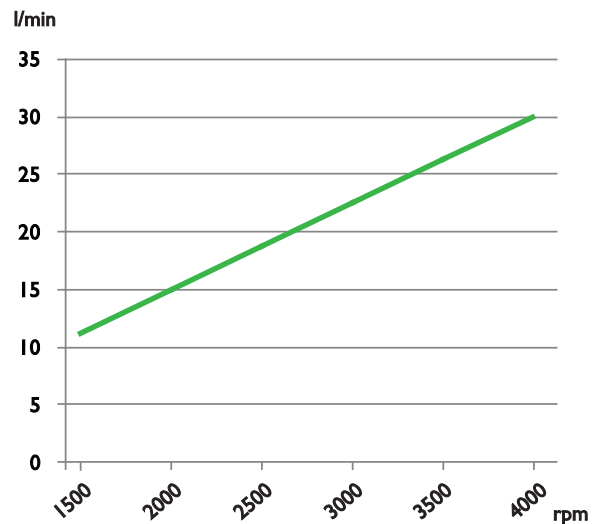

NOTICE

Maximum auxiliary hydraulics oil flow cannot be used with all attachments. Check correct rpm level for each attachment with the help of this graph and the Operator's Manual of each individual attachment. Attachment may get damaged, run too fast, or it may be difficult to control precisely when oil flow is too high.

Lift capacity

Lift capacity describes the load the loader can handle. Lift capacity is limited by the following main factors:

1. Stability of the loader
 - Operating conditions
 - Tipping load of the loader and Rated Operating Capacity (ROC)
2. Maximum lift capacity of the loader

The stability of the loader is the best, when:

- the ground is level
- the loader frame is kept in straight position
- the centre of gravity of the load is as close to the loader as possible
- counterweights are fitted to the loader
- swinging of the load is prevented and all controls are used in a calm and careful manner - sudden movements of the loader or the load can cause the loader to tip over

There are many influencing factors that affect the stability of the loader. Use the load chart and ROC table to estimate the load handling capacity of the loader. Observe the instructions and information given in this Operator's Manual.

See also page 85 for more information about safe handling of heavy loads and for a list of typical factors that influence the stability of the loader.



All counterweights affect stability - Also the driver. Always lower the load on the ground before leaving the driver's seat. If the load is close to the tipping load in the position and in the current situation of the loader, the loader could tip over as a result of leaving the driver's seat.



Falling load hazard - Never exceed the maximum load of the attachment. The lifting force of the loader and the tipping load may exceed the maximum allowed load of an attachment. The Rated Operating Capacity in this Operator's Manual shows information for pallet forks and it does not apply to other attachments. Check the Operator's Manual of the attachment and the identification plate of the attachment for information about their maximum loads.

Overloading an attachment can cause load to drop immediately, or may cause the attachment fail later without visible damage on the attachment.



Risk of tipping over - Follow safety instructions. The lifting capacity of the loader is limited by the possibility of tipping around the front axle.

Pay attention to safe operating conditions whenever handling loads or heavy attachments. The indicated values apply only in favorable conditions. Read the instructions in this Operator's Manual.

Definitions

Any illustration, chart, table or value of tipping load and the ROC table are valid only when the following conditions are met:

The tipping load of the loader is defined as follows:

- Load is distributed evenly on pallet forks A21039
- the centre of gravity of the load is at 400 mm distance from the vertical part of the pallet fork arm
- the attachment weight (90 kg) is taken into account
- driver (75 kg) is seated on driver's seat
- standard counterweights are installed to the loader.

Definition of tipping load

Tipping load is the load which causes the rear tyres of the loader to start to lift from the ground and the loader begins to tip forward.

Tipping load depends on the horizontal distance of the load from the front axle of the loader. For information about the tipping load of this loader with different load distances, see page 48.

Tipping over can happen on all operating conditions and on even ground. If the movement that causes the loss of stability is not prevented or corrected in time, the loader can tip over towards front, causing potentially serious personal injuries or even death.

Tipping over can be caused by a single reason, or as the combined effect of the operating conditions, movements of the loader, and the work situation.

Avoid the following basic situations to prevent the loader from tipping over:

- too heavy load is being lifted
- when the loader boom is moved to another position, the load moves away from the loader, reducing the stability of the loader
- driving or other movements of the loader affect the balance of the loader

Rated Operating Capacity of the loader (ROC)

Rated Operating Capacity (ROC) is calculated from the tipping load. Depending on use and type of attachment, different ROC values can be used.

- 50 % ROC should be used for general bucket use
- 60 % ROC can be used for general pallet fork use. The ROC chart in this manual and on the label in the loader will use this value.
- 80 % ROC can be used with pallet forks on smooth and level ground

Read the instructions in this Operator's Manual regarding safe handling of loads to avoid the situation where the loader will tip over.

If tipping load is higher than the lift capacity of the loader, the ROC is limited by the lift capacity of the loader.

There are many influencing factors that affect the stability of the loader. Use the load chart and ROC table to estimate the load handling capacity of the loader. Observe the instructions and information given in this Operator's Manual.

Maximum lift capacity of the loader

Lift capacity of the loader means the maximum load the loader can lift on a pallet when lifting from ground level to maximum height.

Load charts

The load charts help you to estimate the weight of the load that can be lifted with the loader without tipping over on firm, stable ground. They describe the loads that can be handled at different positions of the loader boom.

The tipping load and Rated Operating Capacity (ROC) of the loader depend on the horizontal distance between the centre of gravity of the load and the front axle of the loader. The ROC label in this manual and on the loader shows the load capacity with pallet forks in different positions of the loader boom. When the load is lifted off from the ground, the loader boom moves further away from the loader, decreasing the stability of the loader. At the horizontal position of the loader boom the load will be the furthest away from the loader, and the tipping load is the lowest. When the telescopic boom is extended the tipping load is further reduced.

To estimate the load carrying capacity of the loader

There are two representations of the lift capacity in this Operator's Manual:

- Rated Operating Capacity (ROC) with pallet forks
 - This information is also presented as a label on the loader
- Load diagram
 - The information in the load diagram is more general and can be applied to other attachments as well to help you to avoid exceeding the tipping load with any attachment.

Load charts of other attachments

In this Operator's Manual there is only a load chart for the pallet forks A21039. All Avant attachments have their own Operator's Manual which include more information about their rated operating capacities when used with different loader models.

Always keep the manuals of all attachments available for all operators of the loader. If you do not have all manuals available, contact your Avant dealer.

Rated operating capacity

To easily determine how much load the loader can handle safely, a table of the tipping load and a calculated Rated Operating Capacity (ROC) are shown in the ROC label. The label is also visible from the driver's seat.

Rated operating capacity depends on type of use of the loader:

- In general pallet fork application the rated operating capacity is 60 % of tipping load. This is shown in the table.
- If operating only on smooth and level ground 80 % of tipping load can be used.

The information shown in the table is the worst-case minimum load, with the conditions listed in this chapter. Actual lifting capacity could be significantly higher, or it may be lower, depending on terrain conditions, available lifting force, and load distribution. Adding or removing counterweights will affect the indicated ROC.

Load chart on the left side of the label:

The graphic on the left side of the label shows the distance of the load in different positions of the loader boom. In this graphic, and in the Rated operating capacity table, the load is placed so that its center of gravity is at 400 mm forward from the vertical part pallet fork arms.

The numbered points are the positions of the rated operating capacity table.

Different positions of the loader boom, columns in the table:

1. Maximum tipping load; stability when lifting load just off the ground with pallet forks
 - a) Rated operating capacity, 60 % of tipping load with pallet forks
 - b) Tipping load (100%) in this position

NOTE: If the tipping load exceeds the maximum lift capacity of the loader, ROC chart shows the maximum lift capacity. In this case the value is accompanied by an asterisk (*).
2. Boom lifted to horizontal position:
 - a) Rated operating capacity, 60 % of tipping load with pallet forks
 - b) Tipping load (100%) in this position
3. Boom lifted to horizontal position; telescopic boom fully extended (least stable position)
 - a) Rated operating capacity, 60 % of tipping load with pallet forks
 - b) Tipping load (100%) in this position

Different loader configurations, rows in the table:

- a Loader frame in fully articulated position, standard counterweight fitted
- b Loader frame in straight position, standard counterweight fitted
- c Loader frame in fully articulated position, with additional 180 kg counterweights fitted to the loader
- d Loader frame in straight position, with additional 180 kg counterweights fitted to the loader

Rated operating capacity label AX, in kilograms

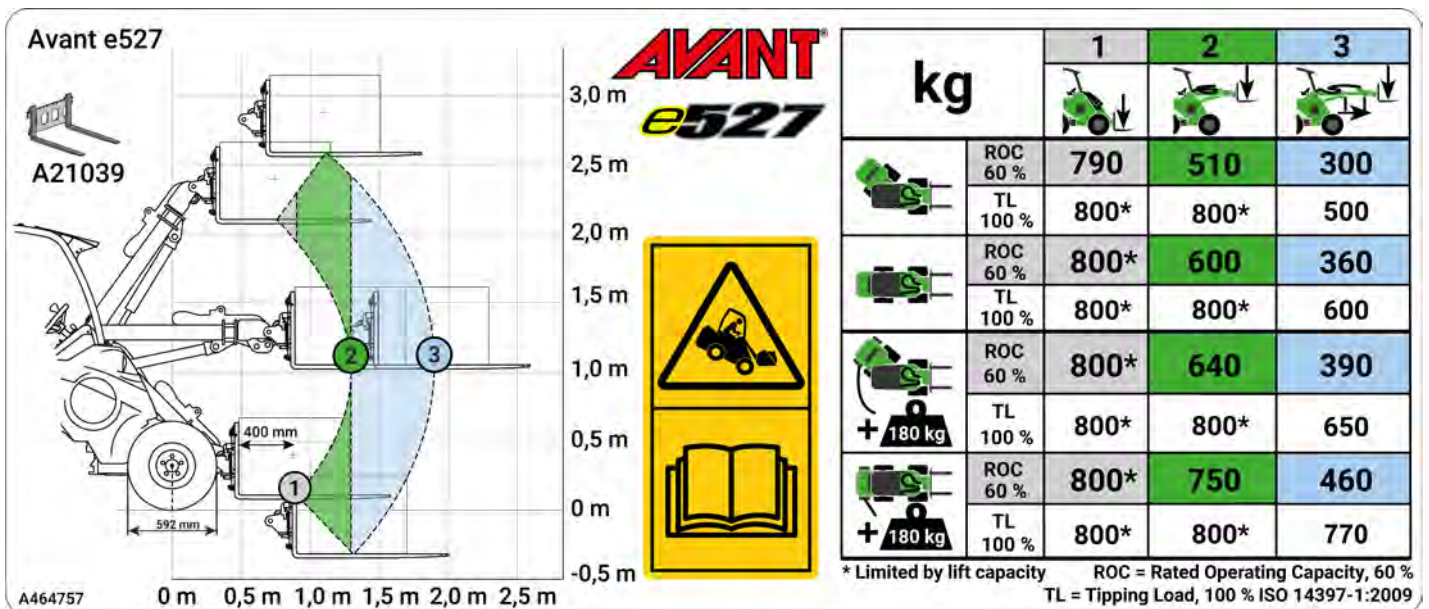
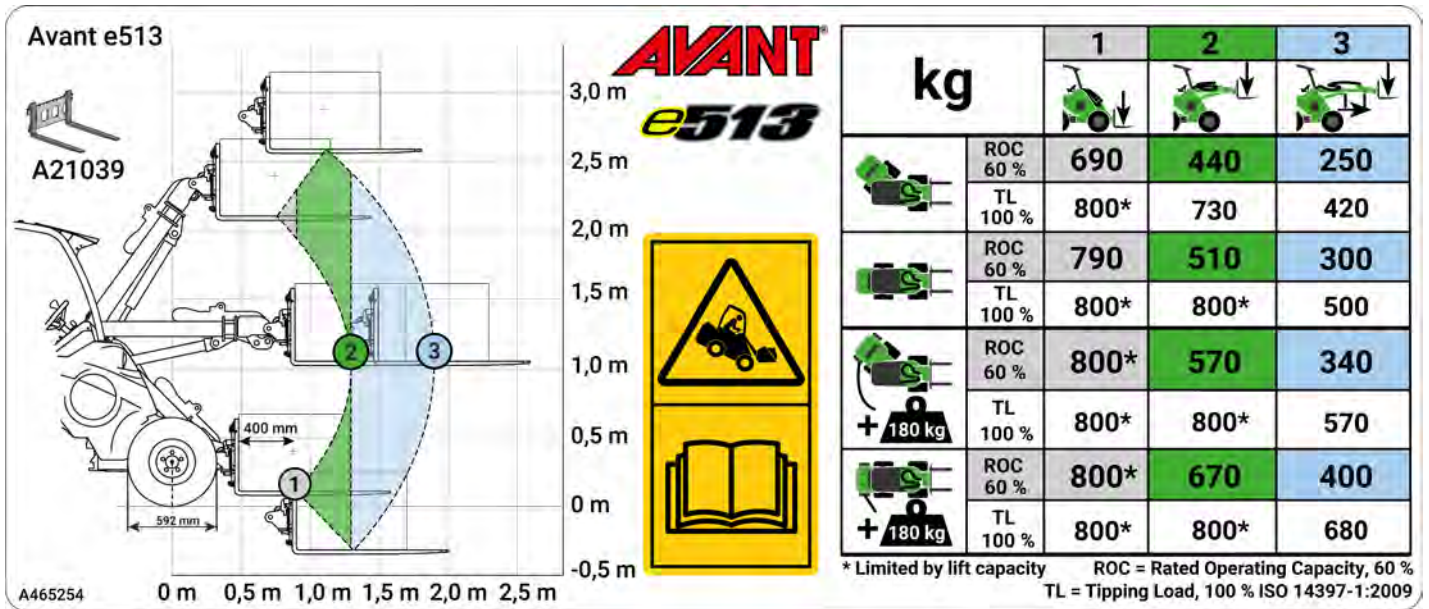

The ROC table is valid, when:

- The ground is firm and level
- Loader is stationary or driven max 2 km/h, with smooth and slow control movements
- Driver weighing 75 kg is seated on the driver's seat
- Load is distributed evenly on pallet forks, with the load centre of gravity at 400 mm from the vertical part of pallet fork arms. The weight of the fork attachment is taken into account in the indicated load value

Tipping load - Load diagram

With the load diagram in this chapter, you can estimate the load handling capability of the loader depending on the horizontal distance of the load from the loader. The tipping load depends according to the distance between the centre of gravity of the load and the front axle of the loader.

The horizontal distance of the load on typical pallet forks is also shown in different positions of the boom. In the diagram, the load is placed at 400 mm from the vertical part of the fork arm.

NOTE: The load diagram represents the forward stability only. It does not refer to maximum available lift force.



Avoid overloading the loader - Know the load and the lifting capacity of the loader. Heavy load can cause the loader to tip over. The diagram is valid only on firm and level ground, with the conditions listed on page 43. The load can exceed tipping load and loader can tip over when you move the loader boom to another position.

Load diagram e513

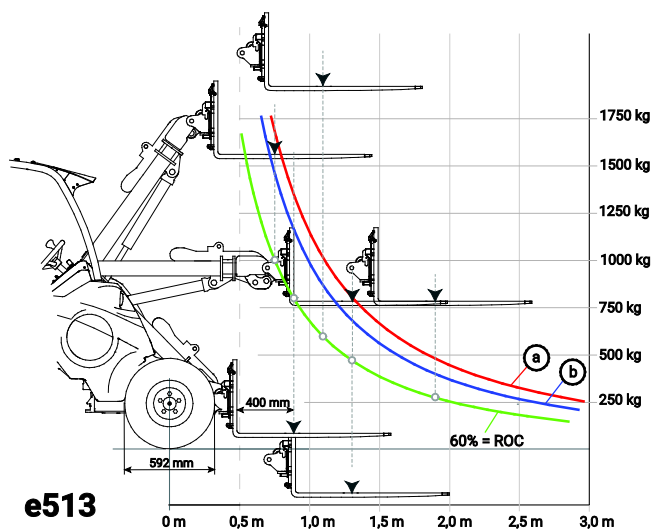

Load diagram e527

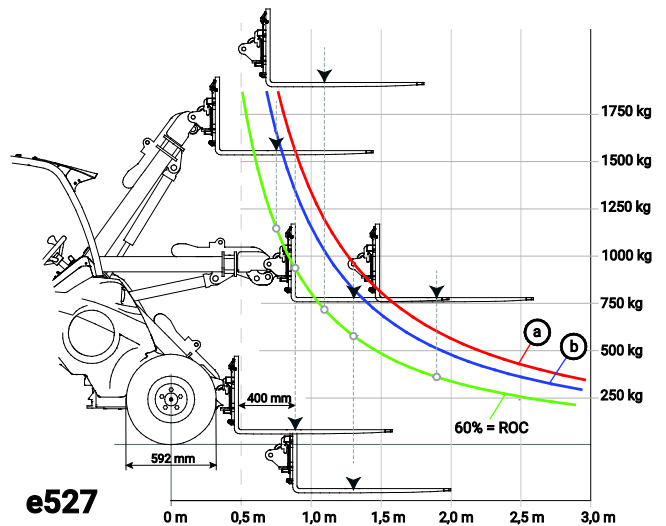

How to read the load diagram

- a Tipping load with the loader frame in straight position.
- b Tipping load with the loader frame in maximum articulation.
- ROC (Rated operating capacity), defined as 60 % of tipping load for pallet forks.

The tipping load chart describes only the stability of the loader to forward direction - it does not refer to maximum available lift force.

The tipping load lines in the chart extend beyond the hydraulic lift capacity of the loader.

Example: If the centre of gravity of the load is 1,1 m in front of the front axle (400 mm from the pallet forks, forks at ground level)

- Tipping load would be about 2000 kg when lifting from ground surface level, with a driver weighing 75 kg, and with the articulated frame in straight position (line a in load diagram).
- This means that in terms of tipping load, a pallet with a total weight of up to about 2000 kg can be lifted just off the ground, but it can't be lifted higher, as the loader would tip over.
 - The hydraulic lift capacity of the loader is less than tipping load.
- When the boom is lifted to horizontal position, the tipping load is reduced to about 1490 kg (line a in load diagram, the horizontal distance of the center of the load on forks increases to about 1670 mm).

How to estimate actual lifting capacity

The actual tipping load and stability of the loader depends on many factors that you must consider when you handle heavy loads or attachments. Listed in the table below are many factors that influence the stability of the loader.

Always keep in mind the conditions listed in the following table.

Influencing factor	How you should take it into account
Position of the loader boom and telescope	<p>Keep load as close to the ground as possible while you drive. Lift only when ready to unload the bucket or attachment</p> <ul style="list-style-type: none"> ▪ See load chart and ROC table to estimate the lift capacity of the loader on level ground. Reduce the indicated maximum load by always taking the local operating conditions into account
The total load on the loader boom	<p>Estimate the combined weight of an empty attachment and load</p> <ul style="list-style-type: none"> ▪ Load chart is based on weight of pallet forks (90 kg) ▪ If the attachment you use is heavier, subtract its weight from the listed tipping load accordingly ▪ See the Operator's Manual of each attachment for attachment weight and possible information about permitted loads.
The distance of the load from the front tyres	<p>The further away the load is from the loader, the less stable the loader is</p> <ul style="list-style-type: none"> ▪ Keep the load as close to the ground and the loader as possible ▪ Never drive while load is lifted more than just off the ground
Straight or articulated position of the loader frame	<p>If you turn the articulated frame, the loader will tip over more easily</p> <ul style="list-style-type: none"> ▪ Keep the loader in straight position when lifting heavy loads
Levelness of the ground	<p>All listed values are applicable only on level, even ground</p> <ul style="list-style-type: none"> ▪ Drive slowly on uneven ground ▪ Keep the load as close to the ground and the loader as possible
Installed counterweights	<p>If counterweights are installed, the loader stability is better</p> <ul style="list-style-type: none"> ▪ Keep standard counterweights fitted ▪ Consider the use of additional counterweights or ballasted tyres for additional stability
Driver presence	<p>Driver acts as additional counterweight</p> <ul style="list-style-type: none"> ▪ Load chart is calculated with a 75 kg driver present on driver's seat ▪ If you leave the driver's seat, loader can tip forward.
Movements of the loader and the load	<p>Lifting of the maximum load is possible only when loader is not moving</p> <ul style="list-style-type: none"> ▪ Operate the controls of the loader slowly and in a smooth manner. Dynamic loads can cause loader to tip over ▪ Secure load on the attachment. If load moves or swings, the loader can tip over ▪ Use correct type of attachment for each type of load ▪ Never lift swinging loads

Controls and options of the Loader

This chapter describes the location and function of the controls of the loader. The location and function of controls may be slightly different in different models and cab versions. See the following pages for information about the controls and the options of the loader.

In This Chapter

Overview of controls	51
Dashboard	53
Control of loader boom, auxiliary hydraulics and other functions	59
Control lever of auxiliary hydraulics (hydraulically operated attachments)	59
Telescopic boom control lever	60
Lever for pump RPM control	60
Parking brake switch	61
Joystick - 6 function (option)	61
Opticontrol®	62
PTO switch	63
Emergency stop button	63
Attachment control switch pack for rear mounted attachments (option)	63
Electric 12 V outlet	64
Diagnostics port	64
Boom floating (option)	64
Boom self-levelling (option)	65
Smooth drive (option)	65
Counterweights	66
Adding or removing counterweights	67
Trailer coupling (option)	68
Extra auxiliary hydraulics outlets, front and rear (option)	69
Reverse buzzer (option)	69
Seat - Seat belt and seat adjustments	70
Suspension seat	70
Lights	71
Cabs (option)	73

Overview of controls

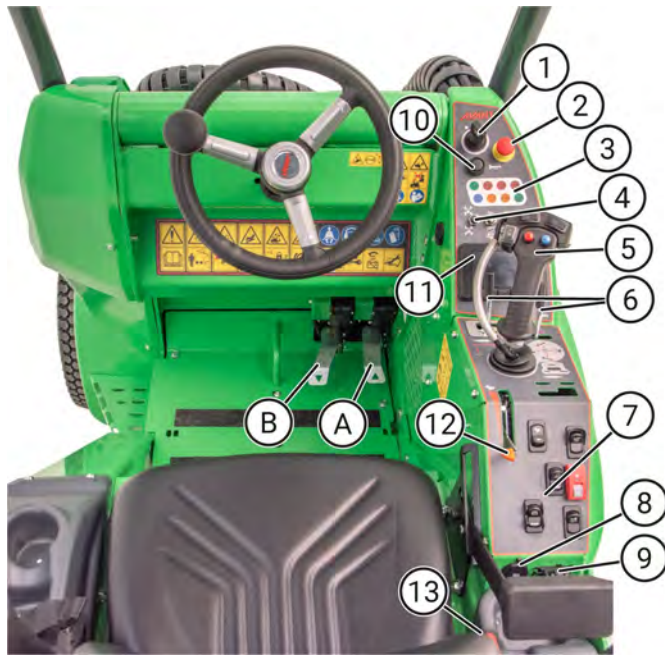

Reference

Page

1.	Dashboard Ignition switch	77
2.	Emergency stop	
3.	Indicator lights	53
4.	Switches on the dashboard	53
5.	Control lever of boom and bucket	
6.	Control levers	59
7.	Control switches on the panel	52
8.	12 V outlet (max 15 A)	64
9.	CAN Diagnostics port	64
10.	Signal horn switch	
11.	Multi-function display	54
12.	Lever for pump RPM control	60
13.	Seat belt buckle	70

Controls in footwell

A	Drive pedal, right: drive forward	80
B	Drive pedal, left: drive backward	80

Switches on the panel

The number of the additional control switches depends on which options have been installed on the loader. The position and order of switches may be different than shown in this chapter.

On loaders with ROPS frame or Cab L:



All switches are located near the lever for pump RPM control.

Switches on the panel					
NOTE: Some of the switches presented here are for optional equipment and might not be installed on the loader. The position of the switch may be different than shown in here.					
	Emergency blinker Optional equipment		Hydraulic locking pins, attachment coupling Optional equipment See page 90		Extra work lights Optional equipment See page 71
	Smooth Drive and boom floating Optional equipment See pages 64 and 65		Windscreen wiper and washer (Only on Cab L) See page 74		Opticontrol® Switch for choosing the operating mode of the Opticontrol® system. Optional equipment. See page 62
	Parking brake See page 61		Warning beacon Optional equipment See page 72		Auxiliary hydraulics outlet selection switch Optional equipment See page 69
	Drive speed range selection switch Avant e527 only See page 81				

Dashboard

Display, indicator lights and all switches for using the loader are on right side of the driver's seat.

ROPS



Switches and indicator lights

Switches on the dashboard:

	Symbol	Description
1		Ignition switch See page 77
2		Emergency stop button
3		Signal horn button
4		Cross-lock valve switch See page 82
5		PTO override switch See page 63
6		<i>Not available in this loader model.</i>
7		Work light switch Standard front work lights of the loader.

Indicator lights



	Symbol	Colour	Description
A		Green	Turn signal indicator (option) Only in Road traffic light kit.
B		Red	Electric malfunction The vehicle ECU has detected an electric error that requires service. Error is potential safety or fire hazard. If this light remains lit, turn ignition switch to OFF position and contact Avant service.
C		Red	<i>Not in use in this loader model.</i>
D		Red	Stop signal The vehicle ECU has detected an error that makes it necessary to stop the loader safely as soon as possible. Turn the ignition switch to OFF position and contact Avant service.
E		Blue	High beam headlights (option) Only in Road traffic light kit.
F		Amber	<i>Not in use in this loader model.</i>
G		Amber	PTO engaged PTO switch is activated: Drive pedals are disabled for using a stationary attachment.
H		Green	<i>Not available in this loader model.</i>

Multi-function display

The multi-function display shows basic information whenever the loader is running. The display also has other information available, which can be selected with the buttons of the display.



1. Ambient temperature (can be displayed in Celsius or Fahrenheit).
2. Instantaneous power consumption.
3. Operating hours of the loader (electric motor run time).
4. Current time.
5. Info and message area: Instead of information listed above, this area can display a message that needs user action. For information about different messages see page 56.
6. Selected drive speed area.
7. Electric motor rpm. Recommended motor rpm area for best economy is marked in green.
8. Current output of auxiliary hydraulics in litres or gallons per minute.
9. Battery state of charge, as percentage.
10. Information area about selected display page.
11. Dashboard views -button.
12. Information messages -button.
13. Settings menu -button.

Control buttons of the display	
11	 <p>Push this button to return to the basic dashboard view. Push again to cycle through available dashboard views.</p>
12	 <p>Push this button to show information messages in the top bar. Active messages start to cycle in the bar. Push again to show basic info bar (positions 1-4).</p>
13	 <p>Push this button to enter the settings menu. View and edit settings of the display.</p>

During recharge:

When a charger is connected to the loader, the display will switch on and show estimate of the remaining time left until the battery is fully charged. The estimated time will vary on the temperature of the battery, and can change significantly during recharge.

During recharge only some of the information that is available in normal use is available.



1. State of charge
2. Charging voltage
3. Charging current
4. Temperature of the coolest battery cell
5. Temperature of the warmest battery cell.







Warnings and symbols on the display

The display also shows information and warnings related to loader, battery, electric motors and inverters.





Warning messages

In addition to the symbols on the display some alerts also display a text on top edge of the display.

Warning and information symbols, electric motor and battery

Symbol	Colour	Explanation
	Yellow	Electric motor fault Electric motor fault. Check info pages of the display for trouble codes. Restart the loader. If problem persists, contact Avant service.
	Red	Electric motor malfunction indicator light (MIL light) Electric motor fault requiring user action. Check info pages of the display for trouble codes. Restart the loader. If problem persists, contact Avant service.
	Yellow	Battery charging Charging cord is connected and battery is charging.
	Green	Battery charged Battery is fully charged.
	Red	Battery charging error Battery is not charging correctly. Check info pages of the display for trouble codes. Contact Avant service.
	Yellow	Battery temperature warning Battery temperature is not in the optimal range. Let the battery cool down or warm up depending on the current temperature. Notice that motor may decrease power if continuing work.
	Red	Critical battery temperature warning Battery temperature is too high or low. Let the battery cool down or warm up depending on the current temperature. Check battery temperature in the dashboard views menu. Notice that loader may stop if continuing work.

Information symbols, loader

Symbol	Colour	Explanation
	Green	Drive speed range: Slow Low drive speed mode is selected. See page 81
	Green	Drive speed range: Fast Fast drive speed mode is selected. See page 81
	Red	Hydraulic attachment locking (Option): switch in open position The locking pins of the hydraulic attachment coupling are unlocked.
	Red	Parking brake engaged The parking brake is on.

Warning and information messages on display

NOTICE

Explanation -column provides information of possible causes for the message.

Restart of the loader may resolve most of the warning messages.

Follow safe shutdown procedure before restart. After shut down wait until display shuts down completely and turn ignition key on.

Contact Avant service if the warning message persists after recommended actions and restart of the loader.

Text on display:	Explanation:
CAN BUS EMCY RECEIVED	CAN bus emergency message is received. No user action required.
CONTACTOR OPEN, CHECK EMERGENCY SWITCH	Motor controller main contactor is open. Possible cause is that emergency stop button has been pressed. Release emergency stop button.
CONTACTOR WELDED	Motor controller main contactor is stuck in closed position. Contact Avant service.
CRITICAL MOTOR CONTROLLER FAULT	Motor controller has detected critical fault and stopped operation. Restart the loader. Contact Avant service if the problem persists.
DRIVE INHIBITED	Motor controller has blocked driving functions. Make sure that driving controls are used correctly.
HIGH VOLTAGE WARNING	Motor controller has detected over voltage.
LOW VOLTAGE WARNING	Motor controller has detected under voltage. Charge battery.
MOTOR CONTROL FAILED	Motor control does not work as expected. Restart the loader. Contact Avant service if the problem persists.
MOTOR CONTROLLER COMMUNICATION FAULT	Motor controller does not receive all necessary CAN bus messages. Restart the loader. Contact Avant service if the problem persists.
MOTOR CONTROLLER CRITICAL TEMPERATURE	Motor controller has stopped working as maximum temperature limit has been reached. Allow loader to cool down.
MOTOR CONTROLLER PRE-OPERATIONAL	Motor controller is in pre-operational state. Restart the loader. Contact Avant service if the problem persists.
MOTOR CONTROLLER TEMPERATURE WARNING	Motor controller has reached temperature limit. Allow loader to cool down.
MOTOR CONTROLLER WARNING	General warning that error message from motor controller was received. Check trouble codes for more info. Restart the loader. Contact Avant service if the problem persists.
MOTOR TEMPERATURE WARNING	Electric motor has reached temperature limit. Allow loader to cool down. Contact Avant service if the problem persists
SEVERE MOTOR CONTROLLER FAULT	Motor controller has been stopped due to severe fault. Restart the loader. Contact Avant service if the problem persists.
VERY SEVERE MOTOR CONTROLLER FAULT	Motor control has been stopped due to very severe fault. Restart the loader. Contact Avant service if the problem persists.
BATTERY FAULT ACTIVE	Detected fault from battery. See trouble codes.
BATTERY TEMPERATURE LOW	Battery temperature is below limit. Warm up battery by charging or continuing work.
BATTERY TEMPERATURE HIGH	Battery temperature is above limit. Allow loader to cool down.

<i>Text on display:</i>	<i>Explanation:</i>
BATTERY CELL BALANCE WARNING	Battery cell balance deviates from average. Restart the loader. Contact Avant service if the problem persists.
BATTERY VOLTAGE LOW	Battery voltage is lower than set minimum limit. Charge battery.
CHARGE BATTERY	Battery of the loader needs to be recharged. Continuing to work will decrease battery life.
ENGINE SERVICE NEEDED IN	Operator is informed from upcoming service time.
CHECK BATTERY CONDITION	Monitored battery values exceeded set limits. Check temperature and cell voltages.
LET BATTERY COOL DOWN	Battery is too hot. Let battery to cool down before continuing work.
WARM UP BATTERY	Battery is too cold. Warm up battery to optimal working temperature.
CAN CONNECTION ERROR, BATTERY	CAN (control area network) connection is not working between display and battery. Restart the loader. Contact Avant service if the problem persists.
CAN CONNECTION ERROR, VEHICLE ECU	CAN (control area network) connection is not working between display and VECU (vehicle electronic control unit). Restart the loader. Contact Avant service if the problem persists.
FASTEN SEAT BELT TO ACTIVATE DRIVE	Machine settings are set to disable drive when seat belt is not connected. Drive functions will work after seat belt is fastened.
RECONNECT SEAT BELT TO ACTIVATE DRIVE	Machine is set to disable drive if seat switch and seat belt switch are not activated in correct sequence. Unfasten and refasten seat belt to activate drive functions.
WRONG START SEQUENCE	Machine is not in correct state for start. Operator is not seated, drive pedal is pressed or PTO mode is active. Follow the correct starting sequence.
RELEASE DRIVE PEDAL	Drive pedal was pressed before driving was allowed or during loader start. Release drive pedal and try again.
OPERATOR NOT SEATED	Seat switch is not active. This message may activate when loader is started or drive pedal is pressed while operator is not seated.
DRIVE DISABLED / CHECK PTO SWITCH	Interlock switch that disables drive functions but allows to use auxiliary hydraulics is active while operator tries to start the loader or use drive pedals. Disengage switch before machine can be started or driven.
RELEASE AUX. HYDRAULICS LEVER	Auxiliary hydraulics control lever is in wrong position (locked on). Starting the engine is not possible if this function is set active in system.
VEHICLE PERFORMANCE REDUCED	VECU (vehicle electric control unit) has reduced power due to system condition, for example too high temperature. Allow loader to cool down.
DRIVE DISABLED, RESET DRIVE LOCK	Driving is disabled because drive lock switch is engaged. Disengage the switch to activate driving functions.
WRONG CONTROL SEQUENCE	Control sequence was not permitted by safety system. For example operator had pedal pressed before being seated. Follow the correct starting sequence.
FASTEN SEAT BELT	Alarms user of open seat belt while driving. Driving functions are active but operator seat belt is not connected.

Menu and parameter texts on display

<i>Text on display:</i>	<i>Explanation:</i>
Reset successful!	Reset of message or value has been done successfully (for example service hours).

<i>Text on display:</i>	<i>Explanation:</i>
Password incorrect!	User typed in wrong password.
Service information	Title of service info page.
Total engine hours	Operating hours of the motor.
Service due	Remaining time to next service.
Next service engine hours	Motor hours when machine should be serviced next time.
Service menu	Title of service menu.
Parameter setting	Title of parameter settings menu.
System information	Title of system information menu.
Error information	Title of error information menu.
System time	Parameter name for system time.
Temperature unit	Parameter name for setting temperature unit (C/F).
Volume unit	Parameter name for setting volume unit (l/gal).
Reset service information	Info text to reset service information.
Insert passcode to reset service information	Info text to insert passcode in order to reset service information.
Display software version	Software version that is installed in the vehicle.
Language	Parameter name for setting language.
Screen brightness (Lights OFF)	Parameter name for adjusting screen brightness when drive/work lights are off
Screen brightness (Lights ON)	Parameter name for adjusting screen brightness when drive/work lights are on
Insert passcode to reset error log memory	Info text to insert passcode in order to reset error log.
Log saved successfully, remove USB	Log is saved on USB stick and USB stick may be removed.
Log reset successfully	Log is reset successfully.
USB-Error	Problem in reading or writing USB stick. Check that USB stick is connected properly
Log empty - log file not written	Log is empty so nothing is saved to USB stick.
System Date	Parameter name for system date.

Control of loader boom, auxiliary hydraulics and other functions

Most of the functions of the loader are controlled with the controls at the right side of the operator: Boom and bucket movements, auxiliary hydraulics (attachments), auxiliary hydraulics pump speed etc., depending on loader model. Following paragraphs show the different functions.

1. Control lever of boom and bucket

The loader boom and bucket are controlled with the multi-function lever (joystick). Moving the lever sideways tilts the attachment. Pushing the lever lowers the boom and pulling the lever lifts the boom.

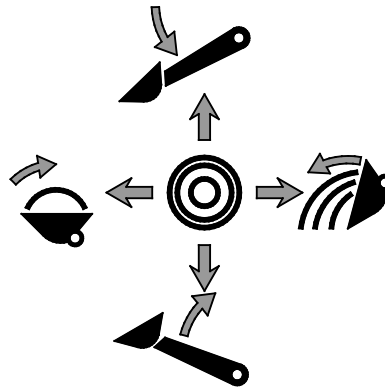
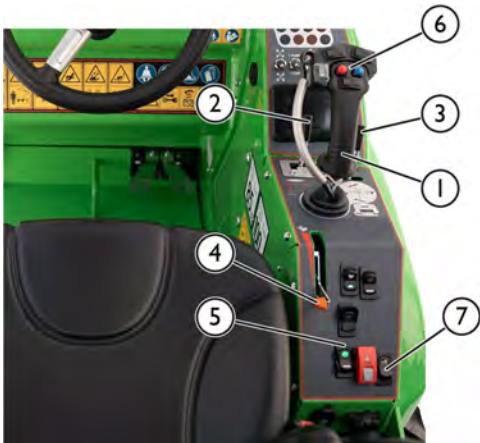

- Pull backward to lift the boom
- Push forward to lower the boom
- Push left to raise the tip of the bucket (filling)
- Push right to lower the tip of the bucket (emptying)

2. Control lever of auxiliary hydraulics (hydraulically operated attachments)

When a hydraulically operated attachment is connected to the loader, the auxiliary hydraulics control lever controls the hydraulic functions of the attachment by controlling hydraulic oil flow to the attachment. If there are multiple hydraulic functions on the attachment, a separate electric switch, the Opticontrol system, or extra auxiliary hydraulics outlet are required, depending on the attachment.

- Operation directions depend on the attachment used.
 - When using an attachment for the first time, carefully move the lever to test and check the operating direction of the attachment.
 - Always read the operator's manual of the attachment.
- For continuous operation of rotating attachments, turn the lever to direction 1 to set the lever to the locking position.
- When operating the buttons of the electric joystick, this lever will also move. Either the lever or the buttons can be used to control the attachment as needed.

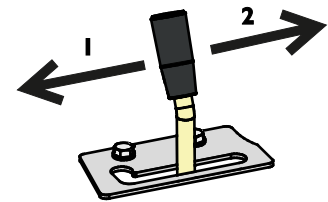

NOTICE

When you operate attachments that require continuous flow, such as attachments with hydraulic motors, it is important to have the control lever in fully engaged position. If the control valve is not fully open, restricting the flow of hydraulic oil, hydraulic system may overheat quickly.

If necessary, adjust the locking plate so that the lever is locked to fully open position.

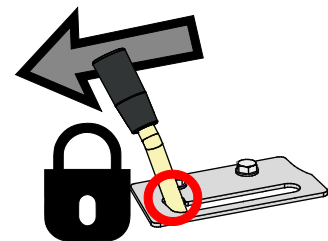

3. Telescopic boom control lever

The telescopic boom makes many tasks easier, also those that do not involve lifting. You can, for example, push material further with a bucket, reach into difficult areas, and improve visibility to the work area with some attachments.



Turn the control lever of the telescopic boom to the right to extend the boom and turn to the left to retract it.

Length of the telescope is 600 mm and additional lifting height is 410 mm.

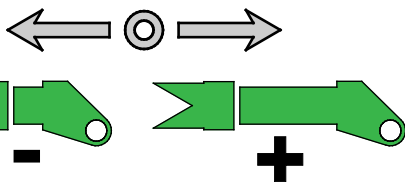

WARNING

Risk of tipping over - Extended boom can cause the loader to tip over. Use telescopic boom with caution. The stability of the loader depends on the distance of the load from the front of the loader. When you extend the boom, you increase the effect of the weight and reduce safe handling capacity. See pages 43 and 85 for further instructions about tipping load and safe material handling.

4. Lever for pump RPM control

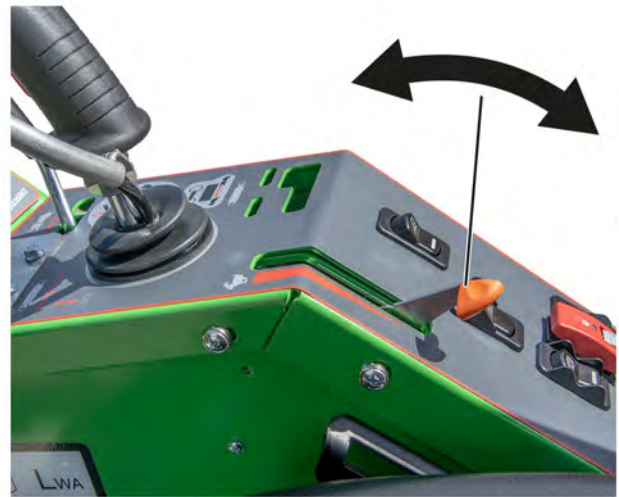

The position of the lever controls only the RPM of the auxiliary hydraulics system. Position of this lever will not affect drive speed or pulling force. The drive system works independently from the auxiliary hydraulics system.

- Push the lever forward to increase rpm of hydraulic pumps and increase auxiliary hydraulics oil flow.
- Pull backward to reduce rpm of hydraulic pumps and to decrease auxiliary hydraulics oil flow.

NOTICE

The position of the lever for pump RPM control will not affect driving speed or pulling force.

Keep the lever set to a low rpm setting to conserve energy.

Use the lever when using the boom or a hydraulically operated attachment.

The electric motors run when the ignition key is switched to ON position, and when the operator is seated on driver's seat or other operating mode is selected. See more information about the operating mode on page 63.

As the lever for pump RPM controls the output of hydraulic flow, this will also influence the speed of a hydraulically driven attachment. In general, the more forward lever is set, the faster the attachment operates. Make sure not to exceed maximum allowed oil flow of the attachment, see Auxiliary hydraulics oil flow on page 41.

The auxiliary hydraulics pump will also provide pressure for the release of the parking brake, and to flush the drive circuit. This is why the auxiliary hydraulics pump will operate whenever the loader is ready to be driven. However, to conserve battery energy, adjust the speed of the pump to a minimum setting whenever not actively using a hydraulic attachment.

5. Parking brake switch

The parking brake is activated when loader is switched off or when hydraulic pressure is otherwise lost due to a failure. Parking brake can be released only when the loader is running, and the charge pump of the drive pump creates enough pressure for the brakes to release.

Switch on the parking brake whenever leaving the driver's seat.

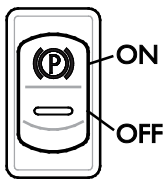

The loader is equipped with a brake system that locks the rear wheels. The parking brake is operated with the switch on the control panel right.

- A red indicator on the switch lights up when parking brake is engaged.
- The green backlight under the "P" is lit whenever the ignition of the loader is in position "ON".



CAUTION

Risk of sudden stop - Do not engage the parking brake when the loader is moving unless in emergency. Using the parking brake while machine is moving may cause locking of wheels and sudden stop.

NOTICE

If the parking brake is engaged repeatedly when the machine is moving the brake plates in the drive motors will get worn quickly. Always stop the loader before engaging the brake.

6. Joystick - 6 function (option)

The loader can be equipped, as an option, with an 6-function joystick. You can use either manual control lever or the electric pushbuttons to control the auxiliary hydraulics.

1. Electric control of auxiliary hydraulics

If the loader is equipped with the optional 8 function joystick, the auxiliary hydraulics can be controlled with electric buttons on the joystick:



Push and hold either button to control the direction of auxiliary hydraulics flow.

- The operation of the buttons depends on the attachment, see the Operator's Manual of each attachment.
- Release buttons to stop.
- Make sure the manual control lever is not locked when operating electric joystick.
- When using the electric switches, the manual control lever will also move. Either way can be used to control the attachment as needed.
- Keep the hydraulic pump setting at 1-pump setting unless higher hydraulic flow to the attachment is required. Lower flow of hydraulic oil will help to control the attachment more accurately.



CAUTION

Avoid abrupt movements of an attachment - Use electric buttons with caution. When you use certain attachments with the electric joystick buttons, the attachments can move abruptly. This can cause falling of material from the attachment, loss of stability, or damage to attachment. Use the manual control lever for work or attachments requiring smooth movements.

2. Anti-slip control switch (option)



An optional switch on the backside of the joystick (2) is the control switch for the anti-slip valve.

See page 82 for more information.

7. Opticontrol®

Opticontrol® is an option that makes it easy to use attachments that have multiple controlled functions. If your loader is equipped with the Opticontrol® system, electric functions and additional hydraulic functions of an attachment can be controlled with the extra buttons fitted on the joystick.

Opticontrol® replaces the previously available Attachment control switch pack option for Avant loaders.

When the Opticontrol® is installed to the loader, there are the following additional features on the loader:

- 1. Additional control buttons on the joystick. Check the Operator's Manual of each attachment to see how to control the attachment.



- 2. An electric socket in the multiconnector connects the electric harness of the attachment at the same time as the hydraulic hoses of the loader.

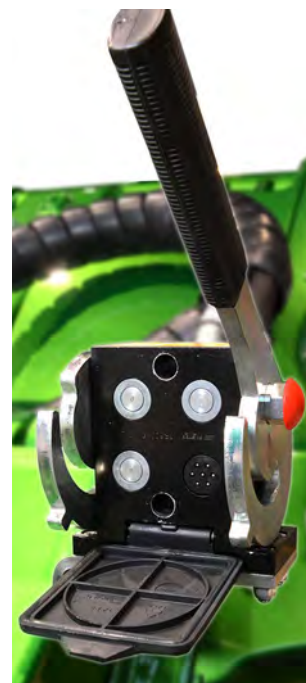

NOTICE

Check the Operator's Manual of the attachment to see how to control each attachment. Function of the Opticontrol® and the buttons on the joystick depend on the attachment.

Operating modes of Opticontrol®

Check the Operator's Manual of the attachment to see how to control each attachment.

There are two operating modes of the Opticontrol®. Choose the mode depending on the attachment.

Keep the switch in OFF position, unless using an attachment that is intended to be used with the combined control mode.



Switch ON (combined control mode)

The combined mode of hydraulic and electric control enables more simple and flexible operation of certain attachments. In this mode Opticontrol® combines the auxiliary hydraulic control of the loader and electric control of the attachment. Auxiliary hydraulic outlet is switched on automatically only when a control button is activated, making control of attachments with multiple functions easier and more efficient. With Opticontrol®, only one auxiliary hydraulics outlet is needed on the loader, when using an attachment that is compatible with the Opticontrol® system.

The attachment must be compatible with this operating mode. In this mode the auxiliary hydraulics control lever must be left to its middle position.

Switch OFF (normal mode)

Use only the electric functions of attachment. Auxiliary hydraulics control lever can be left to its locking position.

Keep the Opticontrol® switch OFF whenever there is no compatible attachment coupled to the loader.

NOTICE

Opticontrol® system in the integrated hydraulic control mode will benefit only specific attachments that are intended to be used with it. The attachment must be originally fitted with its own control valve that is designed to be used with the Opticontrol® option. Some types of attachments may need an extra hydraulics outlet on the loader.

NOTICE

In normal use, keep the pump selection switch at the 1-pump setting to avoid overspeed of the attachment and stalling of the loader. Keeping the switch at the 2-pump setting unnecessarily will decrease the efficiency of the hydraulic system of the loader.



WARNING

Risk of thrown objects, increased noise and vibration, and equipment damage - Check the maximum oil flow of each attachment. Some attachments may eject material at high speed when operated too fast. Damaged machine parts may also be ejected. Too fast operation will cause increased noise, vibration, and wear. Check the Operator's Manual of each attachment and adjust the auxiliary hydraulics oil flow accordingly. See page 41.

PTO switch

The PTO switch on the dashboard is intended for applications where the loader must remain stationary during the use of a stationary attachment. The PTO switch will disable the drive pedals of the loader. Always also engage the parking brake when using stationary attachments.

Emergency stop button

The Avant e-series loaders are equipped with an emergency stop button. This button will open the power contactors to stop electric motors. It will not switch off the battery, so the display will stay on even after the button is pressed.

The emergency stop button is intended only for quick stopping of the hydraulics of the loader, not for regular use. Use the key switch for normal stopping of the loader.

Attachment control switch pack for rear mounted attachments (option)

The functions of the attachment control switch pack are also available for rear mounted attachments. The control switch pack for rear mounted attachments is a separate option that is intended only when using rear mounted attachments together with the hydraulic rear lift device.

For example, when using rear mounted sand spreaders with the rear lift device the attachment control switch pack is necessary. The socket for the rear mounted attachment is located near the rear hydraulic quick couplers.

The switch pack is equipped with a strong magnet. This makes it possible to fasten the switch pack to a suitable location near the driver's seat.



Electric 12 V outlet

A 12 V electric power socket is located near the driver's seat. This standard type outlet is powered when ignition is switched on. Maximum current: 15 A.

When the loader is not equipped with the Opticontrol® system, the electric harness of the attachment can be connected to this socket.

Electric socket on the multiconnector

There is an electric socket for the attachment on the multiconnector if the loader is equipped with the optional attachment control switch pack.

In this case the electric plug of the attachment will be connected simultaneously with its hydraulic hoses. In case there is no electric plug on the multiconnector of the attachment, use the separate electric adapter to connect to the regular 12 V outlet of the loader. You can also contact your Avant dealer to fit an electric plug to the attachment multiconnector.

Diagnostics port

Next to the 12 V electric power socket near the driver's seat there is a diagnostics port. This port is used for software updates and fault code diagnostics by authorized service. Even though the port is USB type, it cannot be used for charging electrical devices such as mobile phones. Keep the protective cover of the port installed at all times.



Boom floating (option)

Avant e513 e527 series loaders can be equipped with boom floating as an option. Boom floating is integrated to the Smooth drive switch.

Boom floating is a system that allows an attachment to follow the surface of the ground. The floating system releases the lift cylinder and allows it to float up and down as the attachment is on the ground. When boom floating is switched on, it is not possible to push down with the boom.

To activate the boom floating:

1. Lower the attachment on the ground to the operating position described in the operator's manual of the attachment.
2. Switch on the floating with a switch on the dashboard, see page 52.



Boom floating indicator light on the dashboard is lit when the system is switched on.

NOTICE

Some attachments have a floating linkage built in the attachment coupling, making use of the floating on the loader unnecessary. Refer to the Operator's Manual of the attachment for more information.

Boom self-levelling (option)



Self-levelling is a system that keeps the attachment tilted in same position when lifting or lowering the boom.

Self-levelling is an automatic hydraulic system. There is a levelling cylinder on the left side of the boom which follows the movements of the loader boom and keeps the attachment level.

NOTE: Self-levelling is disabled when the boom floating is switched on.

NOTICE

When the attachment tilt is turned to extreme position, the boom lift cylinder will have to work against the pressure of the self-levelling cylinder.

To prevent extreme stresses to the loader boom, operate the bucket tilt control to move out from extreme tilt before lifting or lowering the boom.

Smooth drive (option)

Avant e513 e527 can be equipped, as an option, with the smooth drive system which is a suspension system for the boom.

Smooth drive is switched on with a separate switch on the dashboard.

When driving at high speed, or with a heavy load or heavy attachment, the loader may start to swing, making driving unpleasant.

The smooth drive system includes a pressure accumulator, which allows the boom to move up and down. This makes driving smoother and more stable.

NOTE: Self-levelling is disabled when the smooth drive is switched on.

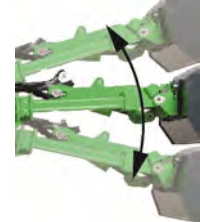

WARNING

Risk of lowering of the boom when switching on boom suspension - Lower boom before switching on boom suspension. Switch the Smooth drive on only when stationary and when the load is close to the ground to avoid change in stability caused by possible movement of the boom when switching on. Keep the Smooth drive off when loading or lifting with the loader.



WARNING

Risk of release of pressurised hydraulic oil - Deactivate pressure accumulator before servicing a loader that is equipped with Smooth drive system. Careless service of hydraulics of a loader that is equipped with a Smooth drive system can cause uncontrolled discharge of hot hydraulic oil because of a pressure accumulator fitted to the hydraulic circuit. See page 114 for more information before service.

NOTICE

Switch off the Smooth drive system when doing loading work or when handling heavy loads. Smooth drive is intended to be used only when driving with the loader.

Counterweights



WARNING

Risk of crushing and impact - Heavy counterweights increase risk of tipping over and loss of control if driving without attachments. Added counterweights can shift the balance of the loader further back, even causing the front wheels to lose contact from the ground. When additional counterweights are fitted, an attachment should be coupled to the loader.

Additional counterweights

Additional counterweights can be installed to increase the stability of loader when handling heavy loads or attachments.

1. 29 kg individual counterweights A35957



Max 3 pcs.

If you install a trailer coupling, only one extra weight can be used.

2. 80 kg counterweight kit A36401



One 40 kg weight installed to both sides of the loader.

3. 180 kg counterweight kit A49063



One 90 kg weight installed to both sides of the loader.

The counterweight kits will not increase the total width of the loader. See page 67 for installation instructions of counterweights.



Risk of loss of control of loader - Too much counterweight can make the front of the loader too light. If you install too much counterweights to the loader, the front wheels of the loader will be easily lifted from the ground. This will make steering of the loader difficult. If counterweights are fitted to handle a certain attachment, remove counterweights if driving without an attachment.



Risk of sudden loss of stability - Always install any counterweight firmly.

Counterweight can fall from the loader on uneven ground or after hitting a wall or other structure. Tighten all fastening screws. After installing the 180 kg counterweight kit, remove their lifting slings from the weights to prevent their use as tie down points.

Adding or removing counterweights

When installing or removing counterweights appropriate lifting equipment must be used.

To install or remove side counterweights (180 kg kit, A49063):

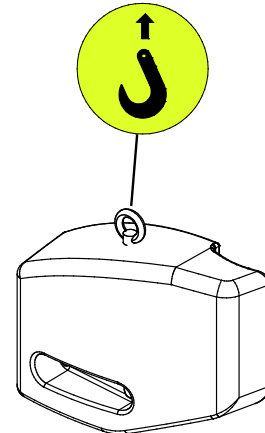

1. Install a lifting eyelet on the threaded hole on top of the counterweight. See picture below.
2. Attach a hook that is equipped with a safety latch to the eyelet.
3. The left and right counterweight are different. Check that the bolt holes of the counterweight are more towards the front of the loader.
 - a) When installing counterweights, place bolts with washers through the holes of the counterweight. Lift and align the counterweight with the holes on the rear frame of the loader. Tighten the bolts firmly.
 - b) When removing the counterweights, make sure to attach the hook onto it before loosening of bolts to avoid dropping of the counterweight.



**DANGER**

Risk of moving or falling of the loader - Never lift or tie down loader from side counterweights. Eyelets on extra side counterweights are for installing or removing the side counterweight only. Never attempt to lift the loader from the counterweights or use them as tie-down points. **Always remove the eyelets from the counterweights immediately after installation work.**

Trailer coupling (option)

The loader can be equipped with a trailer coupling for towing of trailers. There are two types available:

1. 50 mm ball hitch
A417323

Max. allowed
vertical load: 210
kg

Max. towing load:
17,2 kN

2. 50 mm ball hitch
with towing pin
A417337



Trailer coupling can be mounted either directly on the rear bumper or on the extra back weight.

Make sure that the weight on the trailer is distributed correctly so that the trailer cannot cause an upward lifting force on the trailer coupling. It is recommended that you keep an attachment fitted at the front of the loader to add weight to the front of the loader.

**DANGER**

Risk of tipping over - Overload on the trailer coupling may cause loss of control. Tow only light garden trailers. Make sure that the weight on the trailer is distributed correctly so that the trailer cannot cause an upward lifting force on the trailer coupling.

NOTICE

Towing of a trailer on road traffic areas may not be permitted on your area. Find out about local regulations.

NOTICE

The loader is not intended to tow heavy loads over long distances. Towing of a trailer will heat up inverters, electric motors and battery. As a result towing performance will be limited. Allow the loader to cool down to get full performance.

Using trailer lights

Trailer light connector is available as an option for Avant loaders. When towing a trailer with the loader on public roads, the trailer lights must be used. However, notice that using the trailer lights does not automatically mean that towing the trailer is acceptable by the law. Always check your local regulations concerning towing of a trailer.



Extra auxiliary hydraulics outlets, front and rear (option)

In addition to the standard auxiliary hydraulics outlet, the loader can be equipped with a double acting extra outlet. This extra hydraulic outlet can be fitted either to the front of the loader or to the rear. The couplers are conventional type quick couplers.

If installed to the front, the extra quick couplers are located next to the multiconnector.



If fitted to the rear, the quick couplers are located at the rear on the left.



For instructions about use and how to connect or disconnect the extra hydraulic couplings, see page 59.

- Test the operation of the attachment after each time it is coupled to the loader. The quick couplings can be coupled in a way that reverses the function of the control lever.
- The loader can be equipped with either front or rear extra hydraulics outlet - but not with both.
- Keep the couplings clean and use their protective covers.

You can operate either the hydraulic function connected to the standard multiconnector, or the function that is connected to the extra outlet. Simultaneous use is not possible.

Reverse buzzer (option)

A reverse buzzer gives an audible signal whenever reversing with the loader. The buzzer alarms others of an approaching machine. Reverse buzzer has an ON/OFF selection in settings menu. It is possible to select OFF e.g. at night in a residential area when reversing. Always ensure good visibility from the driver's seat and look before you reverse with the loader - the buzzer itself does not prevent accidents.

Seat - Seat belt and seat adjustments



Risk of falling from the loader and getting run over by loader - Never carry passengers. The seating capacity of the loader is strictly one person only. Never carry passengers on any part of the loader or with any attachment.

Always use seat belt while driving. Clean the seat belt regularly with a sponge, warm water, and soap. Use compressed air to clean the buckle.

Replace the seat belt if any damage is seen, or if the seat belt is exposed to high load or chemicals.

Seat adjustments

Make sure that the seat is properly adjusted for easy reach to the operating controls and to keep vibrations transmitted by the seat at minimum. Long term exposure to vibrations may cause health effects. Also, as far as possible, keep the operating terrain in good condition to minimise vibrations.

Suspension seat

The suspension seat has the following adjustments:



1. Seat position
 - The distance of the seat from the steering wheel can be adjusted with the lever which is located under the front edge of the seat.
2. Suspension adjustment
 - Turn the lever to adjust suspension according to operator weight. There are three available positions.
 - Adjust suspension to more stiff position if the suspension bottoms out more than once.
3. Angle of the back rest
 - The angle of the back rest can be adjusted by rotating the knob.
4. Arm rest for the right hand
 - Arm rest supports arm while using joystick.
 - Arm rest can be folded down.



Risk of injury - Make sure that the adjustments of the seat are locked in place before using the loader. Unlocked adjustment of the seat can cause the seat to move, or even slide off from its rails, causing risk of loss of control and injury.

Lights

Work lights

The loader is equipped with standard work lights at the front of the loader, which are controlled with a switch near the ignition switch.

If the loader is equipped with the optional road traffic light kit, the standard work lights are replaced with road headlights. Make sure that the road traffic lights are kept adjusted so that they do not blind oncoming traffic and comply with regulations.

Extra work light kit (option)

The loader can be equipped with extra work lights, making it easier to work in low light. The extra work light kit includes extra lights on the front and at the rear of the loader. The lights are operated with a switch on the control panel.



Avant work lights are LED modules. There are different brightness options, check your Avant dealer.



CAUTION

Risk of burns - Never touch the lamp units. The front surface and the housing of the LED lamps can get extremely hot during use. Never touch or adjust the lights during or immediately after their use.



CAUTION

Risk of dazzling - Check that lights are directed correctly. Bright and powerful work lights may dazzle yourself or other persons nearby. Direct the lights so that they do not disrupt the visibility from the cab.

Headlight, beacon, blinker & reflector kit (option)

The optional light and accessory kit make it possible to register the loader for road traffic use in certain countries.

Requirements vary in different countries, please consult your local Avant dealer.

Always use lights and reflectors which comply with local regulations.

NOTICE

The road traffic light kit itself does not guarantee that the loader can be used on road traffic area. Check your local regulations concerning the use of the loader on road areas, need for registration, and need for insurance.

Light control switch (road traffic light kit)

Loaders that are fitted with the road traffic light kit have a multi-function control switch fitted to the steering column.



The switch has the following controls:

- Headlights
- High beam lights
- Signal horn (duplicate switch, both the switch on near the ignition key and switch on multi-function control are connected)
- Turn signals

Warning beacon (option)

A warning beacon is available as an option. The warning beacon warns others about the moving loader. The control switch for the beacon is located in the control panel, see page 52.

If necessary, for example when driving through low doorways, the beacon can be removed quickly by loosening its retaining screw and then by pulling the beacon out. Place the protective seal on the beacon stand to prevent water entering and damaging the connectors.



Handle the beacon with care. The beacon is sealed and its inner components cannot be replaced or repaired by user.

Mirrors

Adjust the mirrors (if fitted) up enough so that you have an unrestricted field of vision from the driver's seat. Keep the mirrors clean.

If the mirrors have been removed for transportation in the factory, you can find them from the cardboard box in the cab.

Cabs (option)

The e513/e527 can be equipped, as an option, with cab L. It consist of

- windscreen
- wiper and washer
- right side window
- rear window

ROPS



Cab L



Standard and optional equipment on different cab models

	ROPS canopy	Cab L
ROPS & FOPS Certified	●	●
Mounts on standard ROPS frame	-	●
Windscreen, wiper and washer, right side window and rear window	-	●
Door and heater	-	-
Front lights	●	●
Road traffic light kit	■	■
Work light kit	■	■
Panel interior, fabric seat, radio	-	-
Front/rear mudguards	-/■	-/■
Seat heater	-	-
Seat belt	2-point	2-point
Air suspension seat	-	-

- Standard equipment
- Available as an option
- Not available

Cab Safety

Make sure visibility from the cab is adequate. Keep all window panels clean and clear of snow, ice, etc.

Familiarise yourself with the special drive features and space needs of this articulated loader, equipped with cab, on a flat, even and open place.

Remember that, when turning, the cab extends beyond the turning radius of the wheels. This should be taken into consideration especially when driving in confined spaces, in order that the rear of the cab will not get damaged.

Place objects, clothing, and other items in the cab so that they will not hamper with visibility from the loader, and that they do not interfere with the controls of the loader.



In case the normal opening on the left side of the loader is blocked, the windscreen can be used as an emergency exit.

If necessary, the windscreen can be broken with the emergency hammer located in the cab.

Check cab safety equipment

Always make sure that the following equipment are functional and present in the cab:

- Emergency window hammer
- Marking of the emergency exit
- Windscreen wiper and washer
- Rear-view mirrors

Windscreen washer tank (Cab L)

Windscreen washer tank and filler cap on loaders with cab L are located outside the cab, in front of the windscreen on the left.

If ambient temperatures may drop below freezing point, add freeze resistant washer fluid beforehand and use the washer until it runs through the spray nozzle. Freezing water can damage the pump, tank, hoses and their connectors, and the nozzle.



Windscreen washer and wiper (Cab L)

On machines with Cab L the windscreen washer is operated with a switch on the switch panel. The switch has the following functions:

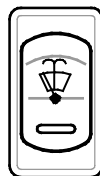

2. Spray washer fluid
1. Continuous operation
0. Off

NOTICE

If used for heating, switch off the air circulation as soon as the temperature in the cab is sufficient, otherwise the cab keeps warming up and moisture starts to condense on the windows.



Risk of collision - Never drive the loader when the visibility is poor. Do not drive unless basic visibility in all directions is achieved. Allow the loader to warm up properly.

Operating instructions



Always remember – safety first. Test all the functions of the loader at an open and safe place. Make sure that there are no persons in the operating area of the machine and the danger zone of the attachment.



Careless operation can injure you or bystanders - Keep the loader under control at all times. Operating a powerful loader and its attachments requires full attention of the operator. Do not perform distractive actions while operating, such as using mobile devices.



Risk of collision - Pay attention to other machines and persons that are moving in the area. Make sure that there are no persons in the danger zone of the loader and the attachment. The danger zone of the loader covers the reach area of the loader boom, the turning area on the side and in the front and rear of the loader. Always lower down the load or the attachment before leaving the driver's seat – the loader is not designed to stay with the loader boom and load lifted. Learn and practice how to operate the loader at a safe area.

Starting the loader

Before start

Before starting the loader do the daily checks, see page 117.

Adjust the seat so that you have a good working position and unrestricted field of vision from the driver's seat. Check that all controls function correctly. Make sure that the operating area is safe.

Check that the attachment is locked and connected correctly, if an attachment is fitted.

Always make sure you have all Operator's Manuals available. Read and follow all operating and safety instructions.

Check the operating area is safe. If necessary:

- Remove or mark obstacles at the operating area.
- Some tasks may require a safety distance to other persons. Plan work ahead to ensure a safe distance to people and to detect and to avoid potential fragile surfaces at the work area. See the Operator's Manual of each attachment for more information.
- If working at an area where there is other traffic, ensure that proper workplace safety procedures are in place. Use the warning beacon of the loader, consider using a reverse buzzer, and switch on lights of the loader. Everyone should wear high visibility clothing.



WARNING

Collision hazard - Prevent unintended movements of the loader. Keep hands and feet away from other controls of the loader while starting.

Ignition key



The ignition key can be switched into three positions:

1. **• (OFF)** In this position:
 - The electric systems of the loader are switched off.
 - Ignition key can be removed.
 - Charging of the battery is possible.
2. **P** In this position, some of the electric systems of the loader can be used:
 - The multi-function display is powered and will show some information, including the state of charge.
 - Some lights of the loader can be switched on.
 - The automatic main switch of the loader (battery) is ON.
 - Charging of the battery is possible.

3. **ON** In this position:
- The electric systems of the loader are in normal operation mode. The electric motors will run, depending on use of the loader and the active operating mode. See more information on page 63.
 - All functions of the multi-function display are available.
 - The automatic main switches of the loader are ON.
 - Charging of the battery is possible.

Emergency stop button

4. The emergency stop button will shut down electric motors of the loader when pushed.

The shut down state is close to the same as when turning the ignition key to the position P. In addition, the motor controllers are on and give contactor fault on display.

To reset the emergency stop button, twist the red button to release it back to original position. Shut down the loader with the ignition key and start again.

To start the loader

1. Perform daily checks (see Maintenance & Service on page 112)
2. Sit on the driver's seat, adjust seat, and fasten seat belt
3. Move the lever for pump RPM control to idle position
4. Make sure that auxiliary hydraulics is switched off (lever in neutral position), 59. *Do not press on the drive pedals.*
5. Turn the ignition key to position ON
 - Automatic battery disconnect switch will be switched on when ignition key is turned
 - The hydraulic pumps of the loader will not operate if the ignition key is in position P



WARNING

Risk of injury to bystanders - Avoid unintended movements of the attachment:

- If the auxiliary hydraulics is switched on during starting and there is a hydraulically operated attachment on the machine, the attachment can move suddenly and cause a dangerous situation.
- Make sure that the auxiliary hydraulics control lever is in neutral position during starting.
- Do not actuate the auxiliary hydraulics control buttons on the joystick (if fitted) when starting.

After starting:

After starting the loader, complete the daily checks, see page 117.

Stopping the loader (Safe stopping procedure)**Safe stopping procedure****Stopping the loader and its attachment to a safe state**

Label on the loader shows the same procedure. See label, page 30

1. Stop any attachment (move auxiliary hydraulics control lever to neutral position, see page 59), set lever for pump RPM control to rear position. Place the attachment firmly on the ground.
2. Lower the boom completely down. If attachment is connected, place it firmly on the ground.
3. Engage the parking brake.
4. Stop the motors by turning the ignition key to the OFF position (turn to the left).
5. Release residual pressure from the hydraulic circuits by all hydraulic control levers back and forth a couple of times.
6. Unfasten seat belt.
7. Prevent unauthorised use of the loader. Take the ignition key with you. If parking on a slope is necessary, use additional wheel chocks to prevent the loader from moving.

Stop if you notice any of the following:**NOTICE**

Stop the loader to a safe state as soon as possible if you observe any of the following symptoms. Find out the cause before restarting.

- Battery charge level has dropped to 10 %. Drive to a charging location and avoid heavy load.
- Electric motor rpm increases and/or decreases suddenly by itself, even if you don't move the throttle lever, or press the pedals
- You notice sudden increase in vibration or noise levels
- You notice a leak

Drive control

Principle of operation

The drive pedals control the speed and direction of travel. The pedals control the electric motor that drives the hydraulic drive pump of the loader.

The position of the lever controls only the RPM of the auxiliary hydraulics system. Position of this lever will not affect drive speed or pulling force. The drive system works independently from the auxiliary hydraulics system.

- Use the pedals to control driving direction and travel speed
- Only the speed is controlled with the pedals. The more you press a pedal, the faster the loader will travel. The pulling force is kept steady by the control systems of the loader regardless of the speed.
- Choose the most suitable drive mode with the drive/operating mode selection switch, see page 81.



Risk of collision or tip over - Use low speed when you practise the use of the loader. Familiarise yourself with the driving of the machine on low speed and on a flat, even and open place. Make sure that there are no persons in the operating area of the machine to avoid injuries that could result from unintended movements. When you have learned how to drive with slow speed operating mode, increase speed gradually and learn how to drive and steer the loader with higher drive speeds.

Drive pedals

Using the drive pedals:



- Driving forward: press gently on the right drive pedal until the machine starts to move slowly.
- To drive backward: press gently on the left drive pedal.
- When you wish to stop gently release the pedal by lifting of your foot, and the machine will slow and stop.

If you need stop more quickly, press the drive pedal of the opposite drive direction. Release both pedals as soon as the loader has stopped, otherwise the loader will immediately start to move to the direction of the drive pedal that is pressed.



Risk of tipping over - Avoid high speed turns. The loader can tip over, if you turn the steering wheel sharply while driving. Slow down before making sharp turns. Always control and steer the loader with smooth movements.

Drive speed range selection switch

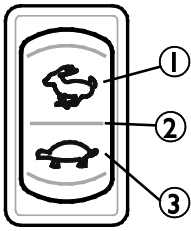

Driving mode selector changes the response of the drive pedals. The system can be optimised for speed, maximum battery life, or greatest accuracy of control.

The maximum pulling force is the same regardless of the position of the switch.

1. High speed mode

Use this mode when you need high driving speed and quick acceleration. The loader will respond quickly to drive pedals.

Battery run time may be short as result.

Use only at open areas.

2. Normal mode

Use this mode for maximum battery run time.

Maximum driving speed and acceleration are limited.

3. Slow / inching mode

This mode provides a modified response to the drive pedal. This helps you to operate the loader in tight spaces, where great accuracy is needed, or when learning to operate the loader.



CAUTION

Risk of loss of control - Be careful when driving at higher speed range. Abrupt control movements can cause the loader to roll over. Do not turn the steering wheel quickly when you drive at high travel speed. Drive slowly whenever carrying loads, driving on inclined or rough terrain, or on slippery surfaces. Always reduce speed before sharp turns.

OptiDrive®

The loader is equipped with the efficient Avant OptiDrive® hydraulic drive system as standard.

The system is designed for optimal hydraulic oil flow, which helps to conserve energy by minimising losses. This is achieved with the use of integrated high efficiency Avant valve blocks.

OPTIDRIVE®

X-lock (Cross-lock) and anti-slip

X-lock (Cross-lock)

The hydraulic drive circuit has a system that allows the wheels on the left and right side of the loader to roll at different speeds. This will help to leave less tyre marks on soft surfaces and reduces tyre wear on hard surfaces. The cross-lock system limits the flow of hydraulic oil between the hydraulic motors on each side, functioning in similar way as a limited parallel differential lock, increasing pushing force of the loader.

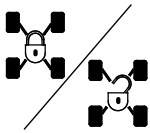

The X-lock system can be switched on from the switch in the dashboard.

The position of the X-lock switch also affects the function Anti-slip valve (optional equipment).

X-lock OFF: In this mode, the hydraulic oil can flow from the hydraulic motors one side of the loader to another. The wheels will roll more freely, and the loader leaves less tyre marks on soft surfaces.

X-lock ON: In this mode the hydraulic oil flow from side to side is restricted. The effect is like a limited differential lock in operation. This improves the pushing capability of the loader. With the X-lock is switched on, the hydraulic motors on one side of the loader may receive larger portion of the total hydraulic flow, leading to spinning of the wheels on one side of the loader.

In general, the X-lock should be switched off during general use, where high pushing force is not needed. Also, when operating on hard surfaces, the X-lock should be switched off to reduce tyre wear. When driving on slippery surfaces the X-lock should be switched on.

Anti-slip valve (option)

If the loader is equipped with the optional anti-slip valve, there is an additional switch on the back of the joystick. The valve equalizes the oil flow between the left and right-side hydraulic motors, improving traction on slippery and uneven surfaces.



The anti-slip valve is engaged by pressing continuously on the switch on the joystick.

As soon as the switch is released, anti-slip valve is released.

The function of the anti-slip valve does not depend on the position of the X-lock switch. Whenever the anti-slip is activated, also the X-lock is switched on automatically.

Operation in cold conditions

Allow the loader to warm up properly

Hydraulic oil temperature influences the hydrostatic drive system of the loader. When the ambient temperature is below 5 °C, make sure the general response to drive pedals is normal. If the drive feels sluggish, allow the hydraulic system to warm up by letting the loader to run at idle until the drive system works normally. Drive carefully until the loader has reached its normal operating temperature.



Risk of decreased braking power - Make sure hydraulic oil is not overheated. When hydraulic oil gets hot, driving characteristics of the drive system change. When the oil is hot and the hydraulic oil cooler has switched on, stopping distance of the machine can be longer than when the machine is cold. If the loader is used constantly in high ambient temperatures, hydraulic oil type and viscosity must be suitable for these conditions. Contact Avant service.

NOTICE

In case the braking power of the hydrostatic drive system has decreased, engage the parking brake. The rear wheels will lock immediately. Parking brake acts as an emergency brake.

Battery system in cold environment

Performance of the battery depends on its temperature.

In cold conditions keep the battery connected to a charger. Battery heating is activated automatically when battery is connected to a charger, or when ignition switch of the loader is in position ON.

Operating in cold conditions will consume more energy due to cold, stiff hydraulic oil. For maximum operating time in cold conditions, keep the loader stored in warm shelter.

Braking performance in cold environment

The braking performance of the loader will depend on the ability of the lithium-ion battery to receive the energy from braking. If the ambient temperature is below +5 °C, the braking performance can be significantly decreased. In case the control systems of the loader observe insufficient braking performance, the parking brake will be applied automatically. Allow the loader to warm up, and connect the charger to ensure sufficient temperature of the battery.

Tips to increase battery life

- Operate the auxiliary hydraulics only at the speed that is necessary for the attachment or work. Too high flow will waste energy.
- If not operating an attachment, keep the lever for pump RPM control at minimum setting. See page 60.
- Use the ECO drive mode or the crawling / inching mode whenever possible to save battery. See page 81.
- Store the loader in within the recommended ambient temperatures - This way the battery and the hydraulic systems of the loader stay warm during use of the loader, and deliver the best performance, even when operating in cold conditions.

When the loader and its battery get cold during storage in cold temperatures, the efficiency of the battery and the hydraulic systems will drop.

Steering of the loader

Steering of the loader is controlled with the steering wheel. The steering system is hydraulically powered. A practical way of steering is to steer with your left hand on the knob of the steering wheel. This way your right hand is free to operate other functions of the loader.

You can steer the loader with the steering wheel even in case hydraulic power is lost. There is an integrated emergency steering system, but more force is needed to turn the steering wheel in case there is a problem with the steering system of the loader.



Risk of tipping over - Keep loads close to ground while driving.

When driving, always keep the loader boom as low and close to the loader as possible. Risk of tipping over increases considerably when there is a heavy load on the loader (a heavy attachment or a big load in the bucket) and the boom is up when driving.



Risk of tipping over - Avoid high speed turns. The loader can tip over, if you turn the steering wheel sharply while driving. Slow down before making sharp turns. Always control and steer the loader with smooth movements.



Risk of tipping over - Never use a high drive speed when turning.

In particular: when the loader boom is up the stability of the machine is much weaker when turning. Keep loads close to ground while driving.



Risk of collision and crushing - Stay and keep hands and feet inside the safety frame. Always remember that when turning the driver's seat extends beyond the turning radius of the wheels.

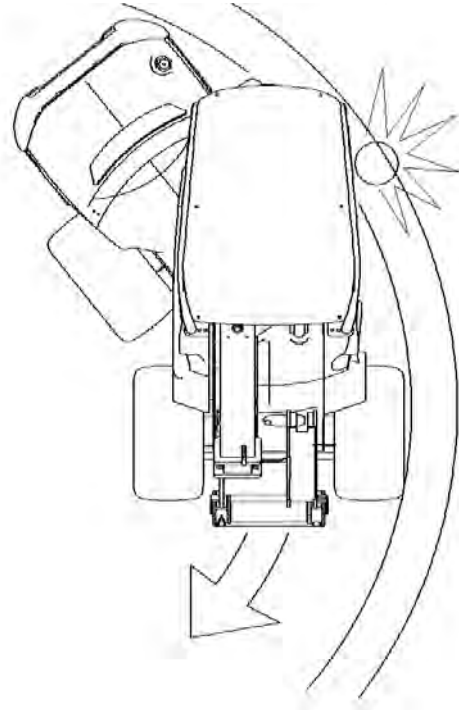

Material handling

Make sure to use correct type of attachment for each handled material. Use correct size and type of bucket for general loose material handling, and pallet forks for handling pallet loads. Read the Operator's Manual of the attachment, e.g. Operator's Manual of the bucket, for further information for safe and correct use. Observe the lift capacity rating of the loader when planning material handling operations.

The loader is not intended for lifting operations for hanging loads; never put slings, chains, or ropes on the loader boom. Never tie or connect ropes, chains, slings, or like attachments, unless told to do so in the Operator's Manual of an Avant attachment.



WARNING

Risk of tipping over - Loader can tip over when you leave the driver's seat. Always put the load down on the ground before you leave the driver's seat. Follow safe stopping procedure shown on page 79.

Handling of heavy loads



WARNING

Risk of tipping over - always carry heavy loads as close to the ground as possible, and only on level ground. Carrying heavy loads can shift the centre of gravity of the loader and lead to tipping over of the loader. Always transport the load as low and close to the machine as possible to keep the centre of gravity low and for the best stability.



DANGER

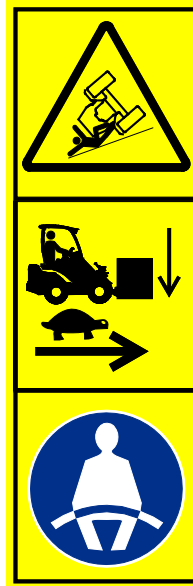

Risk of rolling over - Keep loads close to ground, and drive slowly when carrying load. Always use seat belt.

On uneven ground the loader can roll over to its side more easily. Always drive slow and keep loads close to the ground. Avoid sharp turns also on level ground. Use seat belt to stay inside the protective ROPS. If you do not use seat belt, there is a risk of getting thrown off from the driver's seat and being pinned under the ROPS in case the loader tips over.



DANGER



Risk of tipping over towards forward - Keep load close to ground, drive slowly.

Read Operator's Manual carefully. Never drive with heavy loads lifted. Keep loads, including attachments, as low and as close to the loader as possible. See information in this Operator's Manual about how to avoid tipping over.

In case the loader tips over

Avoid tipping over of the loader with careful operation and with the instructions given throughout this Operator's Manual. However, it is important to know what to do in case the loader tips over.

The loader can tip over either to the side, or towards the front.

In case the loader tips over:



WARNING

Risk of being crushed by the ROPS structure in case the loader tips over - Always use the seat belt and stay within the space protected by the ROPS safety frame.

Always keep seatbelt on to stay on driver's seat and to avoid getting crushed between ground and a loader that tips over.

NOTICE

In case the loader tips over: Switch off the loader immediately. Running the motors and pumps of an overturned loader will damage them quickly and will spill hydraulic oil. As soon as possible, lift the loader back on its wheels to prevent spilling of fuel and oils.

The loader can in many cases be lifted back on its wheels by having a few persons to lift it from the ROPS frame.

Battery thermal fluid can leak, causing major battery damage if the loader is used after the loader has been overturned. Contact service before you attempt to restart the loader.

Working with attachments

Requirements for attachments

Any attachment mounted on the loader must meet applicable safety and technical standards and requirements. An attachment that is not specifically designed for the loader may cause unnecessary safety risks. Make sure that e513 e527 is specifically listed as compatible loader in the Operator's Manual of the attachment. Some attachments may require the use of additional special protective guards or personal safety equipment. See the Operator's Manual of the attachment.

NOTICE

Electric loaders are best suited to work with attachments that don't have hydraulically rotating parts. Many attachments will work for limited time also with electric loaders, but may not work over longer use, as the battery energy is used quickly, or if the power electronics of the loader heat to a point where limiting output hydraulic flow is necessary. Follow compatibility recommendations of each attachment, and if unsure, ask your Avant dealer.



Risk of serious injury - Always make sure that the attachment is intended to be used with this loader model.

- Read the Operator's Manual of the attachment before you begin to install or use any attachment. Always follow the instructions in the Operator's Manual of the attachment.
- Make sure that the attachment is compatible with the loader: Avant e513 e527 must be specifically listed in the Operator's Manual of the attachment. Contact your Avant dealer if necessary. Incompatible attachments can cause risks of injuries resulting from eg. the stability of the loader, contact with moving parts, reduced visibility, or ejected debris.
- Use all attachments only for their intended purpose that is described in the Operator's Manual of the attachment.
- Make sure that the attachment is connected properly on the quick coupling plate of the loader, and as described in the Operator's Manual of the attachment.
- Follow all instructions regarding personal protective equipment, safety distances, and possible additional guards that are needed when operating certain attachments.
- Familiarise yourself with the operation and stopping of the attachment at a safe place. Put the attachment down on the ground and switch off the loader before leaving driver's seat and follow possible additional steps for safe shutdown of the attachment.
- Keep attachments in good and safe operating condition. Follow the inspection, maintenance, and service instructions of the attachment.

Manuals of attachments



Attachments can create significant risks that are not covered by this Operator's Manual of the loader.

Make sure you have all attachments manual available. Wrong use of an attachment can cause serious injuries or death.

Each attachment is accompanied by its own respective Operator's Manual. The Operator's Manual will show important information related to safety, and how to attach, use, and maintain each attachment correctly.



Risk of injuries from incompatible attachments - Make sure attachment is intended to be used with this loader model. Wrong type of attachment, poor locking of the attachment, or wrong technical characteristics of coupling brackets can cause hazards that are not taken into account by design of the loader or the individual attachment. Never use other than original Avant attachments and brackets.

Third party manufacturers of attachment must carry out detailed engineering and risk assessment to ensure safety, performance, and reliability of the combination of the loader and the attachment. Consult your Avant dealer if you are unsure about the compatibility of the equipment with your Avant loader.

Compatibility of attachments

Use only Avant attachments that have been designed for your loader model. Any attachment that is fitted to the loader must be designed to be used specifically with Avant e513 e527, and this must be stated in the Operator's Manual of the attachment. The manufacturer of the attachment is responsible for evaluating the risks related to coupling the attachment and using it with this loader model. Do not operate any attachment if the manufacturer of the attachment has not declared its compatibility with this loader model in writing.

NOTICE

Check the maximum allowed hydraulic oil flow for the attachment. Adjust the speed of the hydraulic pump so that the output flow is suitable for the work and the attachment. See page 41.

NOTICE

Notice that some third-party attachments may have hydraulic oil that is not intended to be mixed with the oil in the hydraulic oil of the loader. Flushing of the hydraulic oil circuit of the attachment may be necessary before coupling to the loader. Incompatible oils can cause wearing of hydraulic pumps and motors.

Coupling the attachments

The attachment is mounted to the loader boom by using the quick coupling plate on the loader boom and the counterpart on the attachment. As standard, the attachment is coupled with two manually operated locking pins of the coupling plate. As an option, hydraulic coupling pins are available, which are controlled with an electric switch. The following steps show the coupling procedure regardless of the type of coupling.

Coupling the attachment to the loader is quick and easy, but it must be done carefully. If the attachment is not locked to the loader, it may fall from the loader and cause a hazardous situation. Never drive with the loader and never lift the boom or tilt the attachments, if the attachment has not been locked. To prevent hazardous situations, always follow the coupling procedure shown below. To prevent hazardous situations, always follow the coupling procedure shown below. Also remember the safety instructions shown in this Operator's Manual.



Risk of crushing - Make sure that an unlocked attachment will not move or fall over. Do not go to the area between the attachment and the loader. Mount the attachment only on level surface. Never move or lift an attachment that has not been locked.



Always read also the additional instructions for coupling and using of the attachment in the Operator's Manual of the attachment. The coupling procedure of an attachment may require additional steps in addition to the basic steps described below. Always follow instructions in the Operator's Manual of the attachment.

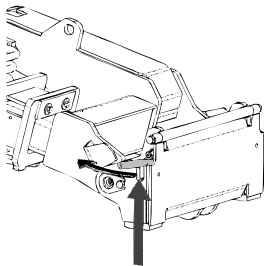

Step 1:

- Lift the locking pins of the quick coupling plate up and turn them backwards into the slot so that they are locked in the upper position.

If your loader is equipped with a hydraulic attachment locking system, see how to operate the hydraulic locking on the following page.

- Ensure that the hydraulic hoses (and the electric harness, if applicable) are not in the way during installation.

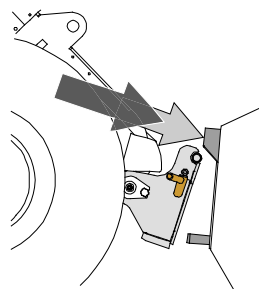

Step 2:

- Turn the quick coupling plate hydraulically to an obliquely forward position.
- Drive the loader onto the attachment. If your loader is equipped with a telescopic boom, you can use it to reach to the coupling brackets of the attachment.
- Align the upper pins of the loader's quick coupling plate so that they are under the corresponding brackets of the attachment.

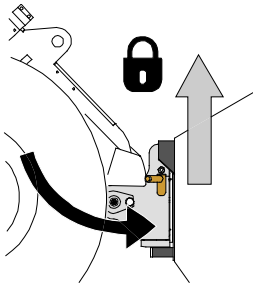
**Step 3:**

- Lift the boom slightly – pull the boom control lever backward to lift the attachment just off the ground.
- Turn the boom control lever left to turn the bottom section of the quick coupling plate of the loader onto the attachment.
- Lock the locking pins manually or lock the hydraulic locking.
- **Always check the locking of both locking pins.**

**DANGER**

Risk of getting crushed under or hit by a falling attachment, risk of loss of control of loader due to dropped attachment - Always ensure that the attachment is fully locked.

- Before moving or lifting the attachment, make sure that the locking pins are in the lower position and come through the fasteners on the attachment on both sides.
- An attachment that has not been completely locked to the loader may fall on the boom or towards the operator, or fall under the loader during driving, causing injuries or loss of control of the loader. Never move or lift an attachment that has not been fully locked with both locking pins.

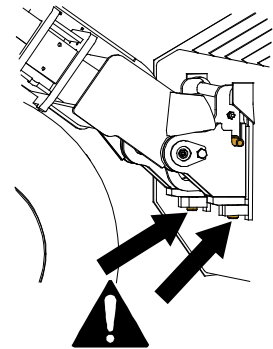
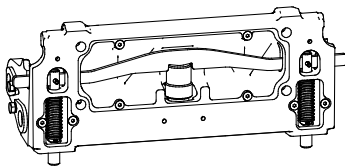
**Hydraulic attachment coupling**

The optional hydraulic attachment coupling plate enables locking and unlocking of an attachment from driver's seat.

A control switch is located at the control panel on the right (see page 52). The switch is equipped with a sliding lock to deter accidental unlocking of an attachment.

There is a hydraulic cylinder inside the attachment coupling plate which moves the locking pins up and down. The electro-hydraulic system works when the loader ignition switch is in position ON.

**DANGER**

Risk of falling of attachment - Familiarize yourself with the controls of the loader.

Avoid dropping of the attachment. Operate the hydraulic coupling only when the attachment is close to the ground.

Always make sure that the locking pins lock properly down in the holes of the attachments also when using the hydraulic locking. Both pins must be locked.

Connecting the hydraulic hoses of the attachment

Hydraulic hoses of the attachment are equipped with the multiconnector system, which connects all hoses at the same time.



WARNING

Risk of movement of the attachment and ejection of hydraulic oil - Never connect or disconnect quick couplings or other hydraulic components while the control lever of the auxiliary hydraulics control lever is locked on or if the system is pressurized. Connecting or disconnecting the hydraulic couplings while the system is pressurized may lead to unintended movements of the attachment, or ejection of high-pressure fluid, which can cause serious injuries or burns. Follow safe stopping procedure before disconnecting hydraulics.

Connecting the multiconnector system:

1. Align the pins of the attachment connector with corresponding holes of the loader connector. The multiconnector will not connect if the attachment connector is upside down.
2. Connect and lock the multiconnector by turning the lever towards the loader.

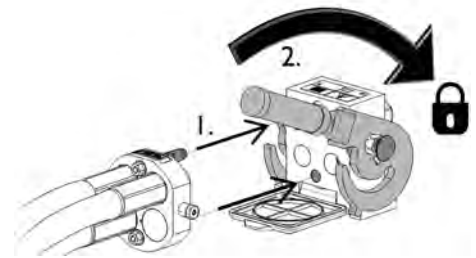

The lever should move easily all the way to its locking position. If the lever does not slide smoothly, check the alignment and position of the connector and clean the connectors. Also shut down the loader and release the residual hydraulic pressure.

To disconnect the multiconnector system:

Before disconnecting put the attachment down on a solid and even surface.

1. Switch off the auxiliary hydraulics of the loader.
2. While pushing unlock button, turn the lever to disconnect the connector.
3. After ending operation put the multiconnector on its holder on the attachment.

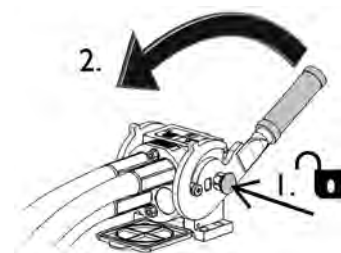

NOTICE

Keep all fittings as clean as possible; use the protective caps on both the attachment and the loader. Dirt, ice, etc. may make using the fittings significantly more difficult. Never leave the hoses hanging on the ground; place the couplings onto the holder on the attachment.

NOTICE

When fitting an attachment, make sure that the hydraulic hoses are not overstretched and are not in a position where they can be trapped during the operation of the machine and attachment.

Using the auxiliary hydraulics

Auxiliary hydraulics (hydraulically operated attachments) are controlled with the lever on the control panel, or with the buttons on the 6-function joystick (See page 59).

The locking position of the lever facilitates operation of the attachments that require constant oil flow (rotary broom, backhoe, etc.). Make sure to release the lever when not operating an attachment to prevent unnecessary energy consumption.



DANGER

Risk of serious injuries from moving parts of the attachment - Keep all persons clear from the danger area of the attachment and loader boom. Going near an attachment that is in operation can cause a serious risk of injury. Switch off auxiliary hydraulics before leaving driver's seat. Operate the controls only when sitting in the driver's seat.

The control lever of the auxiliary hydraulics and electric buttons of the joystick (see page 59) directs hydraulic oil as follows:

1. Moving the control lever towards the locking position will direct hydraulic flow to port 1.

This is normally the normal or positive movement of the attachment.

2. Moving the lever away from the locking position will direct flow in reverse direction, pressure in port 2.
3. The port 3 is a free return line to tank. This is required by some attachments.
4. The port 4 is for the integrated electric socket of the optional Attachment control switch pack.

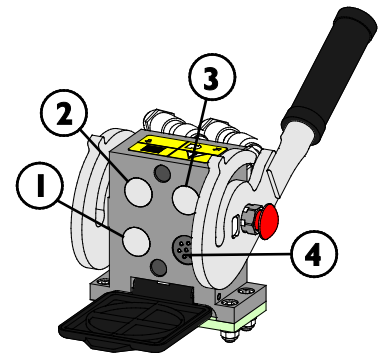

WARNING

Risk of ejection of machine parts, stones, soil, and other debris - Overspeed of the attachment can cause injuries or dangerous movements of the attachment. The attachment can break down in a dangerous way, throw objects, or produce excessive noise and vibrations if operated at too high speed. Never exceed maximum allowed hydraulic flow of the attachment. Check correct operating flow from the Operator's Manual of the attachment, and use the chart on page 41 of this Operator's Manual.

Releasing the residual pressure of hydraulic system

Make sure that there isn't pressure in the hydraulic system that could cause danger during service operations.



Hydraulic energy stored in the hoses and other hydraulic components can cause ejection of hydraulic oil and movements of the hydraulic cylinders or motors. To release the pressure in hydraulic system:

1. Lower the boom down completely and place attachment firmly on the ground
2. Switch off the loader
3. Move all control levers, including the control lever of the telescopic boom and auxiliary hydraulics, to extreme end positions a couple of times

Remember that the boom or attachment can move when releasing the pressure. Move the levers until all movements have stopped.

Extra auxiliary hydraulics coupling

The extra hydraulics coupling is a double-acting hydraulic with two fittings. A pair of standard type hydraulic quick couplings are located at the front of the loader, just next to the multiconnector.

- Before you connect or disconnect standard couplings, relieve hydraulic pressure as described on page 93.
- To connect and disconnect the standard couplings, move the collar at the end of the female fitting
- Note that the protective caps on the loader and the attachment can be fastened to each other during operation to reduce the accumulation of dirt.
- When disconnecting the standard quick couplings, a small amount of oil may drip from the couplings. Wear protective gloves and have some cloth at hand to keep the equipment clean.

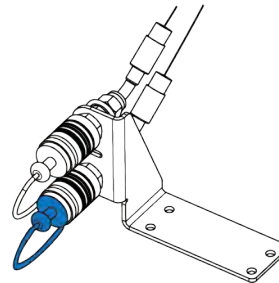

To use the extra hydraulics coupling:

The installed extra outlet is controlled with the same lever as the standard auxiliary hydraulics, or with the buttons of the 6-function joystick. To choose which is used, use the switch on the dashboard:

Switch for choosing which auxiliary hydraulics outlet to use:

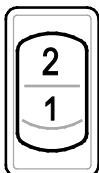

Switch In position 2: The optional extra auxiliary hydraulics outlet

Switch In position 1: Standard auxiliary hydraulics outlet (multiconnector on front of the loader)

The quick couplings can be coupled in a way that reverses the function of the control lever. Test the operation of the attachment after each time it is coupled to the loader. Keep the couplings clean and use their protective covers. You can operate either the hydraulic function connected to the standard multiconnector, or the function that is connected to the extra outlet. Simultaneous use is not possible.

Coupling adapters

Avant offers coupling adapters to help the use of some specific attachments. See the Operator's Manual of each attachment if an adapter can be used.

All adapter types are locked to the quick coupling plate of the loader. The adapters have similar quick coupling system to lock the attachment onto the adapter and loader.

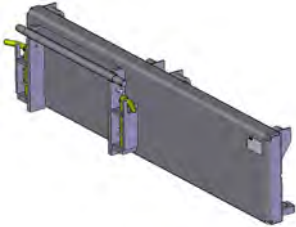

Side shift adapters A37097 and A37166

Side shift adapter is a rigid adapter plate which moves the attachment 60 cm to the right or to the left side depending on the model. It is intended for better side reach with attachment that are used on the ground, such as flail mowers on the side of a road.



Hydraulic side shift adapter A37235

The hydraulic side shift adapter offers easy, stepless side shift of attachment, operated from the driver's seat. The design features strong sliding guides which can also be lubricated.

If a hydraulic attachment is mounted on the hydraulic side shift adapter, the loader must be equipped with the optional second auxiliary hydraulics outlet in the front. The attachment hoses are mounted on the multiconnector and the side shift adapter hoses on the optional outlet.

Contact your Avant dealer for more information about the availability of the side shift adapter.



Tilt adapter A34148 or A36505

With a tilt adapter the attachment can be tilted sideways, which makes it possible to:

- Make different forms to the ground with a bucket or leveler
- Keep pallet fork level when you are driving on surfaces with gradient
- Load pallets that are on uneven ground
- Level ground on uneven surfaces

The tilt adapter is intended mainly for non-hydraulically operated attachments. With the optional second auxiliary hydraulics outlet in the front, it is possible to use hydraulically driven attachments, such as four in one bucket, pallet fork with hydraulic side shift, grabbing tool, and artificial turf attachment at the same time.

**Rotating adapter A424406**

The rotating adapter is intended for same kind of work as the tilting adapter. The fully rotating adapter makes it possible to turn the attachment fully upside down. This can be helpful in levelling work.

**Side shift arm 1200 A449089**

The side shift arm 1200 is intended for mower type attachments that are used on ground surface or just above it. The side shift arm is a rigid adapter plate which moves the attachment 120 cm to the right or to the left side depending on the need.

**WARNING**

Risk of tipping over - A side shift adapter decreases the sideways stability of the loader significantly. Use all adapters only for specific tasks, as instructed in the Operator's Manuals of each attachment. Remove all adapters for general use of the loader. Adapters decrease stability of the loader and must be used only on level ground.

**CAUTION**

Adapter plates reduce lifting capacity - Do not use adapters with heavy loads or attachments. The adapter plates move the centre of gravity of the attachment further away from the loader. This increases the risk of tipping over and can limit the use of heavy attachments.

NOTICE

All coupling adapters are intended only for specific attachments that can be safely and efficiently used with an adapter. The adapters are not intended for general use. Any adapter should be removed from the loader when no longer using an attachment requiring it.

NOTICE

Do not use the bracket adapters that are intended for mounting of 200 series 1 attachments on other loaders. The 200 series 1 attachments are not designed to be used with other loader models than the 200 series.

Storage, Transport, Tie down points and Lifting

Before transporting or lifting the loader:

- Mount the articulation frame lock, see page 115
- Lower the boom down



Always lock the frame lock before transporting or lifting the loader. Also remember to remove the frame lock and test the steering of the loader after transport.

Tie down points

The loader must be tied down securely if transporting it on a trailer, for example. All four tie down points must be used. If an attachment is fitted, also it must be tied down.

As standard, there are four tie down points:

- Two on the front frame, close to the boom
- Two on the rear frame, near rear counterweight

Tie down points at the front of the loader:



Tie down points at the rear of the loader:



Preparing the loader for transport:

1. Check battery charge level. The charge state lithium-ion battery should be at less than 50 % during transport to reduce the risk of fire in case of an accident.
2. Always secure the load. Make sure all equipment is secured also before just a short transport.
 - It may be necessary to tie down attachments separately.
3. Lower the boom completely down.
4. Lock the articulated frame lock.
5. Always use straps or chains that are in good condition and rated for use as load securing device. Check all hooks and locks.
6. Consider weight distribution on a trailer. Sometimes it might be appropriate to load the loader on trailer rear end first.
7. Always make sure the trailer is balanced when loaded in sideways and front/rear directions. Trailer must never cause an upward, lifting force on the trailer coupling of the towing vehicle.
8. Make sure that all panels are locked in place. Remove ignition key and any loose material that could come off during transport.
9. Consider using a transport cover to protect the loader from dirt during transport. See picture below.

Transport cover

To protect the loader during transport, transport cover is available. Contact your Avant dealer.

**NOTICE**

Do not use the full, closed transport and weather cover over long periods of time as it promotes corrosion due to moisture that will condense inside it. The light weather cover can be used.

Transport on trailer

If you transport the loader on a trailer, make sure that the center of gravity of the load is forward from the axle of the trailer. To load the trailer correctly, it may be necessary to load the loader on the trailer backwards.

The center of gravity of a loader without an attachment is located slightly forward from the rear axle. Consider the size and weight of the attachment, and any additional counterweights on the loader. Always secure the loader and its attachment onto the trailer.

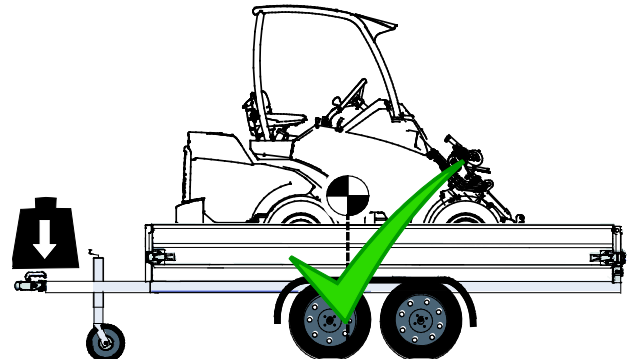

Risk of loss of control of towing vehicle - Never load trailer so that there is lifting force on the tow bar. Trailer must never be loaded so that the centre of gravity is behind the axle of the trailer. If trailer is loaded in this way, the trailer can cause loss of control of the towing vehicle.

Load on the trailer coupling of the towing vehicle must never be negative. When uncoupling the trailer coupling the tow bar can swing up.

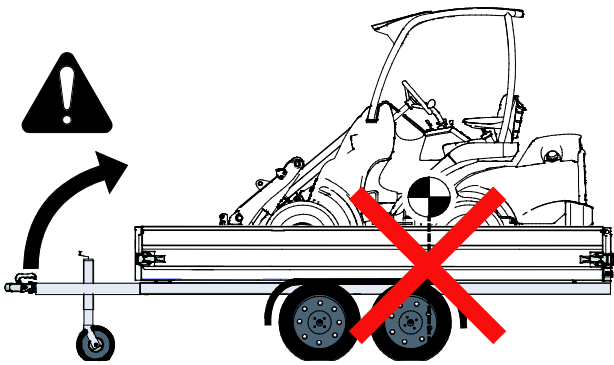

Consider all additional counterweights, attachments, and other equipment when estimating the load on the trailer. Additional counterweights, among other options and equipment, may make the loader heavier than indicated in the identification plate. Never exceed the maximum allowed masses of the trailer, the towing vehicle, etc.

Always check the maximum allowed tow bar weight of the towing vehicle. It is recommended to measure the tow bar load with a scale. Small variation of the location of the loader on the trailer may make the load on tow bar excessive or negative, making the trailer and towing vehicle unstable. Always make sure that there is moderate load on the tow bar within the limits shown in instructions of the towing vehicle.

Tie down options

Optional equipment for frequent trailer transport

If transporting the loader frequently on a trailer, optional tie down brackets are available for easier securing of load.

Tie down bracket A418623 installed at the rear bumper or counterweight



Tie down bracket A418623 installed at the side of rear frame



For side installation, two brackets are needed.

Tie down bracket on wheel hub A423091

Installed to a wheel hub with five bolts:



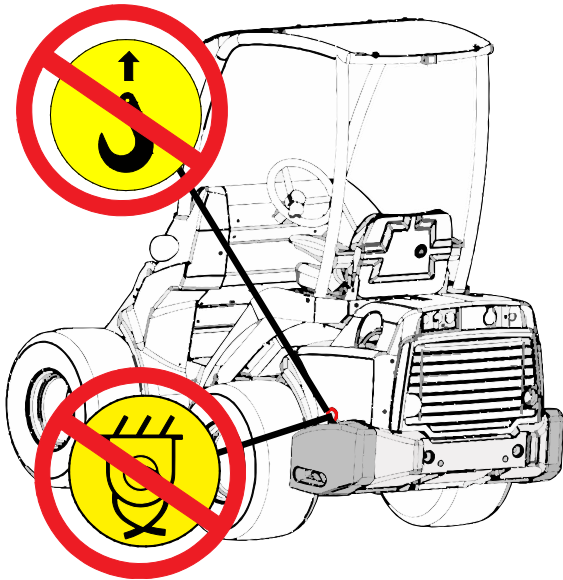

Risk of moving or falling of the loader - Never lift or tie down loader from side counterweights. Eyelets on extra side counterweights are for installing or removing the side counterweight only. Never attempt to lift the loader from the counterweights or use them as tie-down points. **Always remove the eyelets from the counterweights immediately after installation work.**

Storage

If outdoors storage is necessary, protect the machine with the designated weather cover (part no. 65436).



For the best capacity of the battery in daily use, it is recommended to use and park the loader in temperatures between +10 °C and +30 °C. In this temperature range the temperature of the hydraulic oil of the loader is warm enough for high efficiency, and cooling or heating of the battery is not yet necessary.

In other temperatures, connect the loader to a charger when parking it.

Ensure that the state of charge of the battery is sufficient. Recommended charge level is around 40-50%. Never store the loader if the battery is discharged less than 20%. Also, to avoid battery deteriorating, avoid storage with 100% full battery.

- Store indoors, between 0° C and +25° C in a dry environment, air humidity below 70 %.
- Keep battery charge level at around 50-75 %.
- Optimum storage temperature for the battery is just below 20 °C.
- Do not store battery powered loaders in dusty areas. Store away from mists of water, acids, and oxidising agents.
- Check battery charge level at least every three months.

Before long term storage (longer than 2 months)

- Have the periodic service made before storage. Contact Avant service.
- Clean the loader carefully.
- Check and touch-up painted surfaces, if necessary, in order to avoid rust damages.
- Grease the greasing points and lubricate the piston rods of the cylinders with oil.
- Avoid storing the loader in direct sunlight, at high temperatures, or areas with high humidity.
- Inflate the tyres to the recommended tyre pressure.

Storage and transport of battery

Storage recommendations

Discharged battery can get permanently damaged during storage. To prevent damaging the battery during storage, maintain the battery at 50 % to 70 % state of charge.

Check the charge level of the battery every 3 months. Maximum recommended storage time is 6 months.

Transporting a battery

Transport of the full e series loaders on a trailer or by other means of road transport does not require separate preparations. If possible, reduce the Li-ion battery charge level to <50 % before transporting the loader on road. This will reduce risk of battery fire in case of an accident.

Transporting a Li-Ion battery separately from a loader is subject to special requirements and may require licensing. Never remove the battery from your loader. Contact Avant service.

Lifting of the loader

Lifting a loader with ROPS: When lifting a loader equipped with the ROPS frame, use four lifting slings that are approved for lifting purpose, and which are minimum 2000 mm long. Loop the slings around the four ROPS posts. Lifting kit A418706 includes all necessary parts and detailed instructions to lift a loader with ROPS frame.

Make sure that the lifting slings cannot move and that the loader does not swing during lifting. Loop the lifting straps around all four ROPS posts and make sure they are not tied or get damaged by e.g. sharp corners.

Cab L: When lifting a loader that is equipped with the Cab L, remove the window panels (front, side and rear window panel) before lifting.



Risk of dropping of the loader - Use appropriate equipment and follow safety instructions and safe practices when lifting the loader.

- Remove heavy attachment and possible extra weights from the loader.
- Lower the boom down.
- Mount the frame articulation lock to the frame of the loader.
- Follow the instructions given in the Operator's Manual of the lifting kits for each cab type.
- Never lift a loader with persons riding the machine.

Lift the loader as smoothly as possible, and do not allow it to drop or wobble.

The following picture shows the principle of lifting a loader with the ROPS frame using four lifting straps:

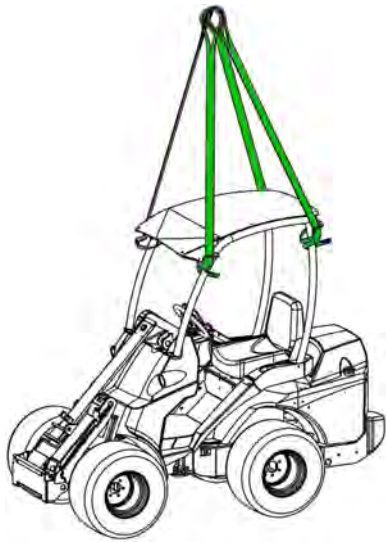
**WARNING**

Risk of dropping of loader - Never attempt to lift the loader from the counterweights or use them as tie-down points. Eyelets on extra side counterweights are for installing or removing the sideweight only. Remove eyelets from counterweights to prevent their use.

**WARNING**

Hazard of falling of load - Never lift loader from its rear guard. Lift the loader only as instructed.

Towing (retrieval of the machine)

The loader cannot be towed. A stopped hydraulic pump and motor assembly will prevent wheels from spinning. In addition, the loader is equipped with a hydraulic parking brake, which can be released only when the hydraulic pump is running and there is enough pressure in the hydraulic system.

In case there is a technical failure, and the loader cannot be started or driven, the loader must be pulled aside with another machine or lifted e.g. with a forklift truck and then transported to service.

Battery and Charging

Follow the instructions in this chapter to ensure the full capacity and service life of the battery.

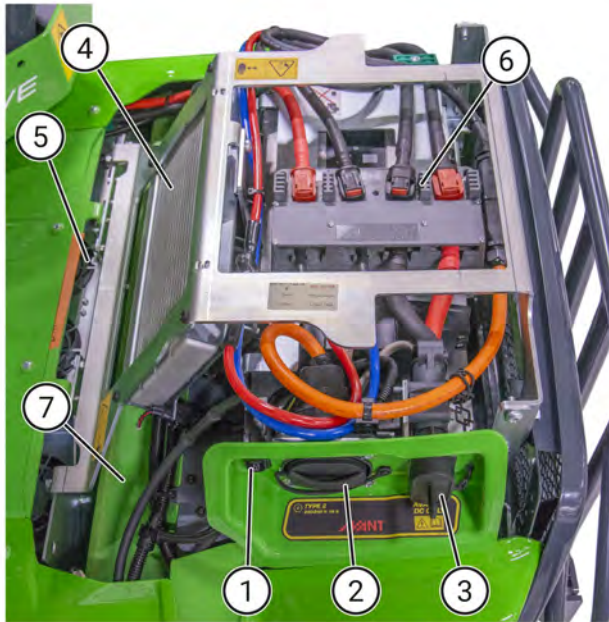

Remove the rear cover to access battery only when charger cables are not connected to the loader.

Under the cover you can see the following main parts of the battery pack:

1. Unlock switch to end charge process and to disconnect cable when using Type 2 charger.
2. Type 2 charging socket.
3. Connector for Avant rapid DC charger
4. Battery cooling radiator and fans.
5. Electric motor and inverter cooling fans.
6. Cable connector terminal
7. Battery pack: Avant Optitemp® Li-Ion battery, 13 or 27 kWh. The battery pack is a full battery assembly with lithium-ion cells and Battery Management System control electronics inside. This battery pack assembly must never be opened.

Correct use and charge cycle and correct operating, safe charging area, and charge temperatures must be taken into account when operating or recharging the loader.

Familiarise yourself with the instructions in this manual. This manual will help you to:

- Ensure a safe charge process
- Keep the battery in good condition and maximize its useful life
- Observe the minimum and maximum recommended charge levels



Electric shock and fire hazards - There are no user serviceable parts under the battery compartment cover. Disconnect charger cables from loader before opening the battery compartment. Keep the battery compartment and cooling systems clean.

Check visually that all cables are in good condition. Never connect or disconnect any electric cables. Cables with orange outer layer are high-voltage cables connected to mains power. If you see damage that has already occurred on any electric cable, or if cables are positioned so that they could get damaged in use, stop using the loader and contact Avant service.

Recommended charging levels

The battery can be charged at any remaining charge level when convenient. For the best service life follow the listed recommendations:

- Charge the battery when there is 20 % remaining charge.
 - Drive to a charging location immediately when the charge level drops to 10 %.
- If possible, do not leave the battery charged at above 80 % charge level when the loader will not be used in few days. The battery will deteriorate slowly if left at high state of charge over long period of time.
- In cold or hot ambient temperatures (< 0°C or >30 °C) keep the loader connected to a charger whenever parked.
 - Never store the loader when battery charge level is low (<30 %).
 - Keep in mind that the loader can use its battery for cooling or heating of the battery to prevent damaging the battery. Plug the loader to a charger in cold or hot temperatures, see page 6.
- Never allow the battery to become fully discharged. This so called deep discharge will damage the battery.

For optimum everyday use, 1-2 fast charge cycles to 80-90 % state of charge (“almost full”) and 1 longer (overnight) charging is recommended.

NOTICE

Avoid deep discharge of the battery. Complete discharge will permanently damage the battery.

Never operate the loader until there is no power left to drive the loader.

Charge the battery as soon as possible whenever the battery level indicator shows that no more than 10 % of charge is left. Battery will wear out quickly in repeated deep discharge cycle use. Recharge a discharged battery with a complete charge cycle as soon as possible.

Operating time

The actual work times will vary greatly, depending on several factors. The following have a high influence on battery use time:

- Work cycle, accelerations and frequent stopping
 - See page 83 for tips about how to increase battery life
- Auxiliary hydraulics pump RPM and load
 - Whenever not using the boom or hydraulics, keep the rpm lever at the lowest setting
- Mass of carried or lifted loads and repeated lifting of heavy loads
- Use of rotating attachments
- Ambient temperatures
- Correct charging of the battery
- Condition of the battery

Charge times

Charge times depend on the temperature of the battery and ambient temperature. The following times are estimates of charge times in normal operating conditions from 0 % to 100 %.

Charge times indicated here are only approximations of charge times in favourable conditions. Actual charge times can vary significantly.

Charging power (max)	e513	e527
3 kW*	5 h	10 h 30 min
6 kW	2 h 30 min	5 h
9 kW	2 h	3 h 30 min

*Standard internal charger, using Type 2 at 13 A load.

Rapid charger

Charger model	e513	e527
16 A	2 h	3 h 30 min
32 A	-	1 h 30 min

To keep the battery in good condition

Correctly used and maintained battery pack will slowly degrade towards the end of its useful life. To keep the battery in best possible condition, obey the instructions regarding recommended charging in this manual.

Each charge cycle of a Li-Ion battery will cause slight deterioration of the battery. All charge cycles are counted as a cycle. A 10 % incremental charge is a cycle, as well as a full 1 % to 100 % charge. However, whenever possible, charge the loader when the battery is at 20 %.

At the end of the battery life the capacity of the battery will degrade to a point where it is no longer practical to use the battery. For battery replacement or repair, contact Avant service.

How to maximize the life of the battery

ALWAYS

- charge the loader latest when the battery charge level is at 10 %
- follow recommended charge levels
- store the loader in recommended storage temperatures
- connect to a charger when loader is parked in hot or cold conditions
- make sure battery charge level is within the recommended range during storage

NEVER

- expose the loader to high ambient temperatures
- Never allow the battery to run completely empty
- store the loader for more than a couple of days when the battery is charged 100 %
- abuse the battery

Leaving the charger plugged

In extreme ambient temperatures, leave the charger plugged also for short term storage, as described on page 6.

Either the quick charger or the external charger can be left plugged in. If both chargers are plugged in, the battery will not get charged.

Drive or use while charging

Using the loader during recharge is not possible. The hydraulic systems of the loader are disabled when charging is active.

Follow correct charging procedure

Always follow instructions of the chargers

For quick charging, use only the Avant external charging station to charge the battery. This ensures that the charge voltage and current are correct for the battery. Other charger types, especially those with higher output current, can overheat the battery. Overheating can cause the electrolyte to boil and battery can deteriorate or its useful life will be shortened as a result.



WARNING

Risk of fire - Use only correct type chargers. Generic forklift truck chargers or other electric vehicle chargers must never be used. See information in this manual.



WARNING

Risk of sparks and electric shock - Never disconnect charger cables forcefully during charging. Charging system is designed to prevent short circuit by locking the connector together during charging. Only when charging is finished or stopped by the user, it is safe to disconnect the charger.

Charging the battery

An integrated charger is standard equipment on all Avant e513 and e527 loaders. To connect charger to the loader, a Type 2 charging station or cable is required.

As an option, the loader can be equipped also with a connector for rapid charging. To use this, a separate Avant rapid DC charging station is required.

Charging connectors:



1. Unlock button for Type 2 charging cable
2. Type 2 Charging connector
3. Rapid charger DC connector

Keep charger socket plugs fitted whenever a cable is not connected to the loader.



WARNING

Risk of fire and battery damage - Use only chargers that are compatible with the loader. Use a high quality Type 2 charger or a separate Avant quick charger to charge the loader. Never connect other connectors to the rapid DC charger connector on the loader.



DANGER

Fire hazard - Check power rating of mains outlet before charging. All electric sockets are not the same. Before plugging a charger to a mains outlet, make sure the power outlet is safe for use for charging of electric vehicles. Contact a licensed electrician to do a check. Under prolonged heavy load, such as charging a loader, a socket can heat and burn regardless of its fuses or original ratings.



DANGER

Always ensure that the electric power outlet is properly installed and rated for the charger application. Never attempt to replace electric connectors by yourself - Risk of electric shock. Always ensure that the power outlet is installed by a professional electrician, and that the power outlet is fully connected, including the grounding/earth wire. Never modify electric power outlets and connectors, refer to a professional, licensed electrician if you are unsure of the suitability of an electric outlet, or need any advice about possible electric connectors, voltage, and ampere ratings at your area.



Risk of electric shock or fire - Use only grounded electric outlets Never use sockets that leave the grounding wire unconnected. Make sure the socket is grounded and connected through a residual current protection switch. The socket must be rated for continuous electric load of at least 13 A. Contact a local licensed electrician to check the socket if necessary.



Risk of cable overheating and fire - Never use extension cables or plug adapters. Extension cables and plug adapters can heat significantly during charging and melt, causing risk of electric shock or fire. Never use extension cables or plug adapters. Use longer type 2 cable or charger unit with a longer cable, if necessary. Bad quality cables or adapters can be inadequately protected against dust and water. Some can even leave the pins of the plug exposed, or leave the grounding wire disconnected, creating a serious risk of electric shock.



Risk of fire and electric shock - Check charger, cables, and mains power outlet. Always check visually that all cables and connectors are clean and not damaged. Damaged, incompletely connected, or inadequate power outlets and cables can get hot, causing risk of fire.

Charge process

Charging is started by connecting either of the charging plugs to the loader. See the following pages for more information about connecting a charger to the loader.

The charging process is controlled automatically by the automatic Battery management system (BMS), and the charging is stopped automatically when the battery is fully charged. You can also stop the charging manually at any stage.

Unplug the charging cable when charging is finished, unless leaving the loader in cold or hot temperatures, where the charger must be left plugged in.

The battery coolant circulation pump will activate during charging. The cooling fans of the loader and battery may start automatically when required.

Display of the loader

The status and phase of charge process is shown on the multi-function display of the loader. The estimated remaining time until a full charge of the battery will depend on the temperature of the battery and can change significantly during charge process.

Ignition key

The position of the ignition key does not affect the charge process with either charger type.

To ensure fire safety during recharge

Follow correct recharge instructions. Damaged cables, low quality extension cords, or incorrect charger can overheat during recharge, or damage the battery, creating a risk of fire.

- Use only the integrated charger of the loader, or a correctly set up Avant charging station.
- Never charge a damaged battery.
- Make sure there is not dust, hay, straw, or other combustible material within the loaders covers. Clean any flammable materials from the loader before charging it.
- Plug the loader only to a grounded mains plug.
- It is recommended to use a mains outlet with a residual current switch device to protect from electric shock in case insulation of cables is damaged. Those devices must be tested periodically according to their instructions.
- Use extension cables only if necessary. Use as short cables as possible. Choose only high-quality cables with large conductor cross-section. Poor quality cables can heat up and even burn. During charge with the integrated charger of the loader, the electric power that runs through the mains cable can be as high as about 3600 Watts.
- Avoid cable loops to prevent heating of the cable. Unwind any long cable that is coiled, otherwise the cable can overheat and burn.
- Make sure the fuses of the mains plug are adequate for charging of the loader.
- Make sure all charger and battery cables and their insulations are not damaged and that they are connected correctly. Never use damaged charger cables.

Type 2 charging

The loader can be charged from any public Type 2 charging station, or by using a separate charging cable that connects to a mains outlet.

As standard, there is a 3 kW internal charger on the loader. The loader will require an electric outlet rated for 13 A continuous load.

Check that the power outlet is suited for charging electric vehicles. Consult with a licensed electrician to determine if the mains outlet is fit for charging.

For quicker charging using the Type 2 charging system, the loader can be equipped with the optionally available more powerful internal chargers, as shown in table below.

Charger configuration	Charging power	Charge current
1 charger (standard)	3 kW	1 phase 13 A / 230 V
2 chargers (optional)	6 kW	2-phase 2 x 13 A / 230 V
3 chargers (optional)	9 kW	3-phase 3 x 13 A / 230 V

Charging speed

The configuration of the integrated charger determines the maximum power that the loader can charge the battery. However, charging speed will also depend on other conditions:

- Temperature of the battery: If the battery is cold or hot, the charging power will be automatically limited.
- State of charge of the battery: The battery charging power will decrease once the battery is nearly full.
- Maximum power setting or type of a charger station, or a portable charger

To start charging with Type 2 charger**NOTICE**

All power drawn from electric power outlet is not charged into the battery. Some of the power drawn from the electric outlet is used for battery heating or cooling. Some power is also lost as charger efficiency losses.

1. Read and follow instructions of the charger.
2. Connect charger cable to charging station or connect portable charger to an electric outlet that is fit for use for charging electric vehicles.
3. Connect Type 2 plug (C) to the loader
 - Green light (A) will start to flash
 - After about 4 seconds the lock symbol (B) will get lit, the cable will lock to the loader and the charge process will start automatically.
4. During charging process
 - Green light (A) will flash on the charge plug unlock switch
 - Display of the loader will show approximate time remaining to full charge.
5. Once the battery is full, the flashing green light (A) will stay solid.
6. Disconnect cable by pushing the charging cable unlock switch (B).
7. Cover charger socket with the plug. Store charging cable or portable charger appropriately.

When charging is active, the charger plug is locked into the Type 2 socket on the loader and can't be removed.

Charging can be stopped at any time by pushing the unlock switch near the charger socket of the loader.

External rapid charger

Rapid charging requires a special charger that is intended for charging Avant electric loaders. Shown in the picture below is an example of an external Avant charging station. Contact your Avant dealer for more information about different charger models.

Rapid charger:



The external charger has a IEC 60309 system type electric plugs (also known as a 3-phase CEE plug). There are two models of chargers:

A426117 is intended to be connected to 400 V / 16 A 50 Hz 3-phase electric power outlet

A425411 is intended for 400 V / 32 A 50 Hz 3-phase power outlet.



CAUTION

Risk of fire, and electric shock from sparks and arcing - Shut down external charger or unplug from mains power before disconnecting it from the battery. During charging high current passes through battery connector. If charger is unplugged abruptly, arcs or sparks can form that can also damage the charging connector. **Always stop the charging process by pressing the STOP button on the external charger before disconnecting the charger from the battery.** See page 109.



DANGER

Risk of battery overheating, fire, and rupture or other damage of battery cells leading to release of battery chemicals - Use only approved Avant chargers for rapid charging. If you use an incompatible charger, the charge voltage and current may be wrong for each phase of the charge, causing risk of battery fire, overheating of the battery, or other damage to battery cells.

How to use an external charger

The following quick guide is on the external charger (label A433683A). It describes the use of the external charger.

During typical use of the external charger the charge process will begin after the cables are connected, and will stop when the battery is full. In normal use you do not need to push any of the buttons of the charger, unless you need to interrupt the charge process and disconnect the battery before it is fully charged.

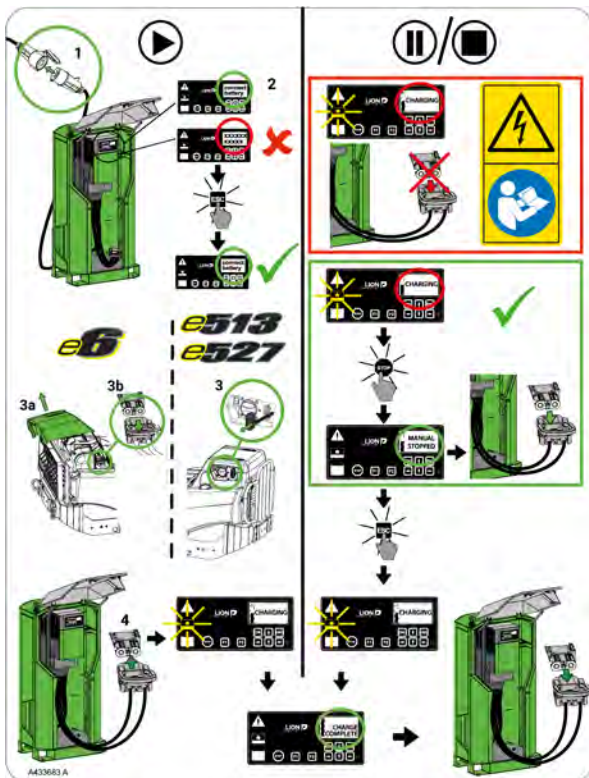

The label A433683A on the external charger describes the following:

How to connect the charger and to start the charging process (left side of label):

1. Check that the charger, mains power outlet, charging cables are intact
 - There are no signs of damage on the cables or connectors
 - Cables must not be twisted, looped around any object or edge, and they must not be stretched too far. A cable that is connected to the loader must hang loosely on the ground.
2. Connect the charger to external mains power.
3. Check the display of the charger. If there is "Connect battery" on the display, proceed to step 4. If there is something else on the display, press ESC-button repeatedly until text "Connect battery" is shown on display.
4. Connect the external charger to the loader.

Progress of the charge process is shown on the display of the external charger. Once the charge cycle is complete, or if the charge is stopped manually, you can disconnect the charger from the battery.

How to pause or stop the charging before disconnecting the charger (right side of label):

During recharge there is high electric current flow through the connector. Abrupt disconnecting of charger can cause sparks. Always stop the charge process, or wait until charge is complete, before disconnecting the charger from the battery.

Press the STOP-button on charger to stop the charge process. The display of charger will show "Manual stopped". You can now disconnect the battery safely.

If you want to resume charge process, press the ESC-button. After the charge process is complete, it is safe to disconnect the battery.

This manual shows the basic use of the external charger. More information about the external charger can be found from the separate operator's manual of the charger.

Charging speed

The fastest charging rate is possible from around room temperatures and up to + 40 °C temperature of the battery. The Battery Management System will automatically adjust the charging rate according to ambient temperature and the internal temperature of the battery.

Charging speed is always affected by

- Model of external charger
- Internal temperature of battery: If the battery is colder or hotter than the optimal charging conditions, charging speed may be reduced
- State of charge of the battery: Once the battery is nearly full, the charge speed will be reduced.

Controls of the external charger

NOTE: The following information is only a brief description of the basic use of a typical external Avant charger that is intended specifically for charging an Avant loader. See the operator's manual of the charging unit for more information about the charger. The instructions shown here are applicable only for the external Avant charging units with a control panel that is shown in a picture below.

The control panel of the charger, shown in picture below, has several indicator lights and button keys. Of these functions a few are described below:

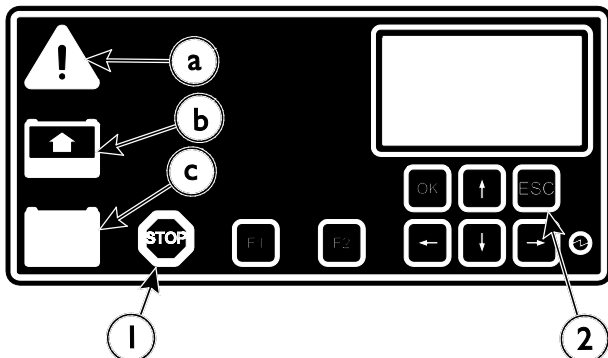

1. STOP-button (1): You can interrupt the charging process by pressing the STOP-button. Always stop the charging process by pressing the STOP button before the battery is disconnected.
2. ESC-button (2): If you have interrupted the charging process with the STOP-button, you can resume the charge by pressing the ESC-button.

- a Red alarm light (solid or blinking)

An alarm is active. If switching off the charger and disconnecting cables does not solve the alarm, see the operator's manual of the charging unit.

- b Yellow charging light (solid or blinking)

Battery is being charged

- c Green (solid): charging is completed

Green (blinking): The charging process has been manually stopped. Press ESC (2) to resume charging.



Risk of battery overheat and fire

- Use only the built-in charger of the loader to ensure correct charge cycle. The current and voltage output are optimized in the integrated charger, and the external Avant chargers intended for this loader, to ensure quick charge and long life of the battery.

Modified or different type of charger can overheat the battery or cause sparks, creating fire. Too high current or voltage can damage the battery or its control electronics.

NOTICE

The Avant charger unit is correctly set up specifically for Avant loader models e6, e513, e527. Never modify the parameters of the charger. Editing of the parameters is locked from users. Incorrect charging parameters can damage the battery. Contact Avant service if necessary.

Service and maintenance



Risk of personal injuries - If the loader is damaged or poorly maintained it can cause or increase risks of unsafe operation.

To ensure long service life it is important to maintain the loader in good condition. The maintenance procedures listed in this chapter can be performed by trained or otherwise experienced operators. If you are not sure about how to do any service operation, ask for additional information before you start any service or maintenance work.

If the maintenance schedule is not followed, and services made are not marked in the table in this Operator's Manual, the warranty may not cover for damages of the loader.

Service parts are available through your Avant dealer or authorised service. Contact your local Avant service or dealer for any questions or information.

Safety instructions



Always keep the following instructions in mind when doing any maintenance or service:

- Switch off the loader and let it cool down before starting any service operation.
- Put the service support on the boom lift cylinder when working under the boom. Keep boom lowered otherwise.
- Install the frame lock when lifting the machine, and, for instance, when changing tyres.
- Disconnect the battery before working on the electric system or battery.
- Check hydraulic hoses for cracks and wear. Follow the wear of the hoses and stop operation if the outer layer of any hose has worn out. If there are signs of oil leakage, put a piece of cardboard under the probable leakage place in order to find the leakage. Never use hands to search for leaks, read instructions in this Operator's Manual about safe handling of hydraulic components. If you find a fault, the hose or the component must be replaced.
- Contact your Avant dealer or service for spare parts.



Risk of burns, cuts, and sprayed oil or dirt - Use Safety goggles and gloves during all maintenance operations. Always wear protective gloves, safety goggles and protective clothing. Hot surfaces and sharp edges can cause injuries. Also general skin contact with oil and grease can be harmful, wash hands thoroughly after contact with oil.





High-pressure ejection of fluid may penetrate skin and cause serious injuries - Never handle pressurised components.

Before handling hydraulic components, make sure that the hydraulic system of the attachment and the loader are completely de-pressurised. Do not hold your hand near a fitting when tightening or opening it, and never use hands to search for leaks. If a leak is suspected, set a piece of cardboard to detect a leak.

See a physician immediately in case hydraulic fluid is injected through skin, or if it is suspected. Immediate specialized medical care is important to limit the possible serious injuries caused by injected oil. Initial injury might be barely visible, but serious injury can develop within just hours.



Risk of injuries and burns caused by leaking hydraulic oil - Never operate loader or attachments if there are hydraulic leaks.

Check hydraulic hoses and components only when the loader is safely stopped and hydraulic pressure is released. Repair all leaks as soon as you have noticed them, because a small leak can quickly change into a big one. Leaking hydraulic fluid can cause serious personal injuries and is also harmful to the environment. Hot hydraulic oil can cause severe burns.

Check hydraulic hoses for cracks and wear. Follow the wear of the hoses and stop using the loader if the outer layer of any hose has worn out. If you find a fault, the hose or the component must be replaced.

Also repeated or prolonged skin contact with hydraulic oil can be harmful, wash hands thoroughly after contact with oil.



Falling of load - Risk of crushing.

Always secure the loader boom with the provided service support, before going under the loader boom. Remove any load and attachments from the loader before service or maintenance.



Consider the environment



The fluids in the machine are harmful to the environment. Never allow fluids to leak in the environment.

Take waste oil and fluids to recycling station. Find out about your local requirements concerning the recycling or disposal of other components.

See information related to the battery of the loader on page 136.

Loaders that are equipped with Smooth drive system:

Risk of burst of hydraulic oil - Isolate hydraulic accumulator before service. If the loader is equipped with the smooth drive option, a pressure accumulator is fitted to the hydraulic circuit of the boom. Do not disconnect any hydraulic component before the accumulator has been isolated from the circuit and the residual pressure has been released.

Access to battery and electric motor compartment***Access to battery compartment*****NOTICE**

The rear cover should be opened only for cleaning and general check. There are no parts requiring other maintenance in the battery compartment.

Before accessing the battery compartment, shut down the loader and allow the loader to cool.

To open the rear cover, open the quick locks on the cover and lift it aside.

Access to electric motor compartment

Access the electric motor and pump module only for cleaning. There are not parts inside that require maintenance.

Always make sure the loader is switched off before opening any cover.

Install all covers back when finished with cleaning. Covers act as ducts for cooling air, and they protect from electro-magnetic interference as well.

There is no storage space in the battery compartment. Never place any objects on or around the battery. Any object placed in the battery compartment can damage or loosen electric cables or connectors, cause short-cuts, or hoses related to thermal management.



Risk of burns - Allow loader to cool before opening covers. Electric and hydraulic parts may be extremely hot after use.

The adjacent warning label is located visibly below the rear cover. Hot areas include the hydraulic components and hoses, and surfaces of electric motors and inverters.

Storage inside cab

There are storage areas around the driver's seat and elsewhere in the cab. Place objects so that they will not interfere with controls of the loader and will not block visibility.



Risk of short-circuit and damage - Do not use battery compartment as storage space.

There is no storage space in the battery compartment. Do not place any objects in the battery compartment, and always keep battery compartment clean. Loose items near battery can disconnect or damage electric cables or cooling pipes, causing risks of short-circuit or other damage.

Installing of service support and frame lock

Installing boom service support:

The red service support of the boom lift cylinder is located at the tip of the boom, behind the attachment coupling plate.

Make sure that the boom stays up during maintenance operations by putting the service support on the lift cylinder piston rod. Secure the service support by locking it on the piston rod with the long screw that is on the support.



WARNING



Falling of load - Risk of crushing. Always secure the loader boom with the provided service support, before going under the loader boom. Remove any load and attachments from the loader before service or maintenance.

Service support stored at the tip of the boom



Service support in place



Frame lock:

A red frame lock bar is stored below the driver's seat structure.



This lock bar is intended to lock the articulated frame to make the loader frame stay straight during e.g. lifting or transportation.

The holes for the frame lock bar are on the left side of the loader, below the access step.

1. Slide the hook type end of the bar through a hole on the rear frame of the loader.
2. Turn the bar towards the front hole. The other end should remain locked in the hole on the rear frame.
3. Align the holed end of the bar and the frames by turning the steering wheel. This can be done without starting the loader.
4. Once aligned, slide the bar and lock with its cotter pin.



Daily inspections and periodic service schedule

The loader must be serviced and maintained in order to keep it in good and safe condition. This part of the manual shows the maintenance and service tasks and intervals of the loader and its battery. There are more detailed instructions about each service operation, in numerical order, on the following pages.

In this manual the needed service is divided into parts:

1. Daily and routine maintenance, which all users of the loader can do without special equipment or training. As part of your daily routine, check the condition of the loader and its equipment before starting it. Remedy any issues found.
2. Periodic maintenance of the loader and its battery, where special equipment and training may be needed. The service schedule establishes a more thorough examination of the loader in addition to the daily maintenance.

Some periodic service procedures are intended to be made by qualified service technicians. These service operations are marked in the service schedule table, and in the instructions of each service operation. Authorized Avant service points have the special tools and equipment that are needed.

All maintenance and service operations are intended to be made when the loader is shut down, except those checks that are specifically intended to be made with the loader switched on.

Follow the recommended service schedule. Keep records of services made. Contact Avant service if you are unsure about any of the service procedures, or if you need spare parts.

NOTICE

Keep the loader in good condition. Always do the daily inspections and follow the maintenance schedule. Lack of maintenance can significantly and quickly shorten the useful life of the loader, and cause safety risks.

First service after 50 hours of use

NOTICE

Remember to perform the first service after 50 hours of use. The first service is vital for the performance and endurance of the hydraulic systems. All hydraulic components break-in during the first 50 hours of use, causing the hydraulic oil and filters to collect these initial wear products. If the first service is not made on time, the hydraulic pumps, motors, and valves may wear beyond repair. The warranty will not cover for damages that are caused by neglected service. The first service includes also tasks that are otherwise important for the safety and reliability of the loader.

Keep record of service and maintenance

NOTICE

Record of periodic service is on page 141 of this Operator's Manual. All periodic services must be filled and signed to the table by the service technician who has made the service. Damages or wear that are caused by lack of service are not covered by warranty.

Daily maintenance and inspections

- Do a walk-around check of the loader before each working shift. Complete the tasks listed below daily before starting to use the loader and after each 10 working hours.
- Check at least the following listed points. Do not use the loader if you notice problems with any of the listed items, or in other parts of the loader. See the following pages for detailed description of each inspection listed below.
- Adjust the seat and mirrors (if fitted) so that you have a good working position and unrestricted field of vision from the driver's seat. Check that windows and mirrors are clean.
- Check that all controls of the loader function correctly.
- Check the operating area. If necessary, remove or mark obstacles that could cause risks to safety or stability of the loader.

Daily and weekly inspections		Check daily or before each work shift	Check weekly
1	Ensure battery charge level	●	●
2	Check the general condition of the loader, its equipment, and safety labels	●	●
3	Clean the loader, battery compartment, cooling systems	■	●
4	Add grease to the lubricating points	■	●
5	Check the boom, pivot pins, and other metal structures visually	●	●
6	Check tightness of bolts, nuts, and fittings	●	●
7	Check wheels	●	●
8	Check the attachment and the quick coupling plate	●	●
9	Check hydraulic oil level	■	●

Inspections after starting the loader		
10	Test the movements of boom	●
11	Test drive control and steering	●
12	Test parking brake	●

- Maintenance operation
- When necessary

Periodic service and maintenance

In addition to the items listed in the daily and weekly inspections, the following service procedures must be completed periodically.

Some of the listed service operations require specialized skills, equipment, and knowledge, and they are intended only for professional technicians. Contact your Avant dealer to locate your nearest Avant service.

Service schedule for periodic service		After the first 50 hours of use	After every 400 hours of use or annually (whichever comes first)
1	Change hydraulic oil	●	●
2	Change hydraulic oil filter	●	●
3	Clean or replace hydraulic oil tank breather	-	●
4	Check battery and electric cables visually	●	●
5	Check hydraulic hoses, fittings, and other hydraulic components	●	●
6	Check pressure of hydraulic system*	●	●
7	Adjust pressure of hydraulic system*	■	■
8	Check and adjust slide pads of telescopic boom, replace if necessary*	●	●
9	Check fastening and operation of drive motors*	●	●
10	Check the safety frame, seat, seat belt, reverse buzzer, and all installed lamps and reflectors	●	●
11	Service the hydraulic attachment locking system*	●	●
12	Check articulation joint	●	●
13	Reset the service reminder*	●	●

- Maintenance operation
- When necessary

*Service operations that are marked with an asterisk are intended for professional service technicians.

Daily and weekly maintenance

1. Ensure battery charge level

Check that battery charge level is at least 20 %. If it is lower, charge the battery before starting work.

Make sure the battery is sufficiently charged depending on use, planned storage period, and ambient temperatures. See page 6 for information about storage in hot or cold environments. To ensure long battery life, never allow the battery to become fully discharged during storage.

2. Check the general condition of the loader

- Check the underside of the loader and ground for leakages. Also check ground/floor surface for signs of leakage.
 - Never operate the loader or its attachments if you have noticed a leak. Repair all leaks before use.
 - If there are signs of leak on or around the battery, do not start the loader.
- Check if the loader must be cleaned before continuing with other daily maintenance procedures in this manual. Damaged parts or other faults might not be visible if the loader is dirty.
- Check that all safety decals are in place and legible.
 - Never operate loader if safety decals are damaged or missing. Replace missing or damaged safety decals before using the loader.
- Check the condition of the safety frame, seat belt, lamps, and other safety equipment:
 - Safety frame (ROPS) and protective roof (FOPS) must be fitted. Safety structures must not have visible damage or deformations. They must be replaced with new ones after any incident.
 - Make sure all lighting devices and reflectors are functional and clean
 - Check operation of reverse buzzer (if installed).
- Check the metal parts for damages.

- Do not use the loader if you see damaged, bent, heavily corroded, or deformed metal parts. Contact Avant service for service, if necessary.
- Check the condition of the loader after cleaning of the loader. For more instructions about inspecting the metal structures, bolts, and fittings, see sections starting from page 122.

3. Clean the loader

Cleanliness of the loader is not only a question of outer appearance. A dirty machine will run hotter and can cause poor performance, shorter battery life, or stopping of loader to overheat.

Pay special attention to the cleanliness of the battery, electric motors, inverters, charger, the hydraulic pump compartment, hydraulic quick couplings and the oil tank cover.

All surfaces, painted and others, will stay in better condition when they are cleaned regularly.

Make sure all lamps are clean and functional.

Keep the access steps clean

Always keep the access steps, the floor of the loader, and the pedals clean. If there are worn grip surfaces on the steps or the floor, replace them with new ones.

A. Clean the exterior of the loader

Clean the outer surfaces of the loader with water hose and mild detergent.

You can also use a pressure washer to clean the outer surfaces of the loader. Use low pressure and only wash outer surfaces with a pressure washer. To avoid damage, do not spray at hydraulic components, controls of the loader, electric parts, operator's area, decals, or radiators. Never use pressure washer to clean the inner parts of the loader.

Also, wash the hydraulic components (hoses, cylinders), any external electric component, decals, and the radiators carefully, never with high pressure washer.

Wipe the hydraulic quick couplings, and the oil tank cover with a rag.

Clean also the space between the front hydraulic motors periodically by removing the cover panel at the front of the loader.

After cleaning the exterior of the loader grease all greasing points.

B. Clean the interior of the loader

Clean cab and interior with appropriate mild detergent and cleaning supplies. Keep the cab and the driver's seat clean to reduce exposure to dust.

C. Clean the inside of the rear frame

Keep the inside of the rear frame clean. Dust, hay, and other combustible materials on and around electric components will cause a fire hazard. Dirt in the rear frame can also cause mechanical damage to the electric cables, hydraulic hoses, or other components.

Never use pressure washer to clean the inner parts of the loader or the battery. Electric parts or the battery may become damaged.

Clean the inside of the rear frame using compressed air, and wet cloth. Wipe parts clean with cloth, or use a brush or sponge. Do not pour water on the internal parts of the loader.

Never spray in the elecompartment with a pressure washer.

Service hatch at the bottom of the loader

There is a service hatch under the loader to help with the cleaning of the rear frame. Remove the service hatch, fastened with two bolts, before cleaning the engine compartment to remove dirt from the rear frame. Reinstall the cover plate after cleaning to protect the internal components of the loader.

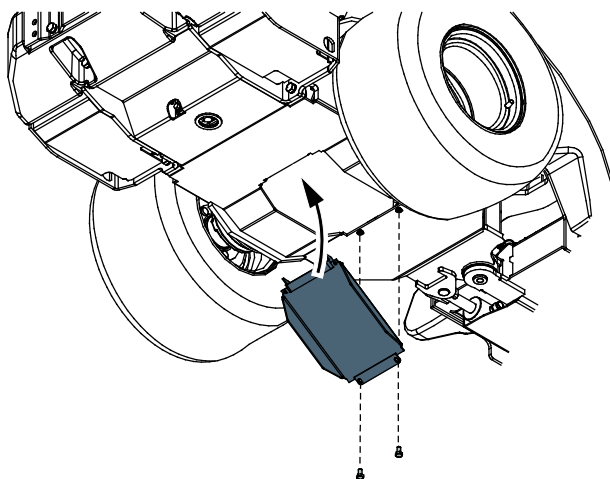

D. Clean cooling systems

NOTICE

Proper cooling is essential. To prevent overheating, clean screens, cooling fins, and external surfaces of electric motors, inverters, and the charger. Avoid spraying water at wiring harness or any electrical components.

NOTICE

The loader is equipped with a hydraulic oil cooler, which is located at the right side of the loader, near the controls of the loader. Make sure to clean the oil cooler cell with compressed air every time you are servicing the loader - and even more frequently if the loader is being used in dusty conditions.



CAUTION

Risk of injury to fingers - Keep away from cooling fans. Cooling fans start automatically.

There are cooling fans at four locations on the loader:

1. Battery cooling system on top of battery
2. Electric motor compartment cooling fans on top of electric motor module
3. Hydraulic oil cooler at right side of front
4. Cooling fan in integrated charger

All of these must be kept clean to ensure reliable operation and long service life of the loader.

Keep all coolers clean to ensure reliable operation and long service life of the loader. If you operate the loader in dusty conditions, clean the cooling fans and surfaces more frequently.

NOTICE



Risk of battery damage - Never use pressure washer or water hose to clean the battery, battery compartment, or electric motor module. Electric connectors and insulators may get damaged. Use an air gun and a damp cloth to wipe the battery and electric motor related components clean. Always make sure loader is switched off before cleaning any part inside the rear frame. Clean battery carefully as instructed in this manual.

Use an air gun to blow to clean the cooling fans, battery cooling radiator, motor module cooling fans, and surfaces of the motor module and battery.

The plastic parts of the battery can be cleaned using water-soaked rags without additives. After cleaning, the battery surface must be dried by suitable means, e.g. with compressed air or cleaning cloths. Pressure washer, solvents, strong cleaning agents, or hot air devices must not be used.

Remove any dirt and debris from around the battery case. Pinched rocks and other material around the battery can cause damage to the battery housing over time.

4. Add grease to the lubricating points

NOTICE

Greasing of the pivot points is essential to avoid wear of joints. Lack of greasing can cause significant damage to the articulation joint and boom pivots in short period of time.

The following table and pictures show the location of grease nipples. Check the lubrication points before each work shift.

Make sure all joints are lubricated and clean. Suitable lubrication interval depends heavily on operating conditions. The need for lubrication must be checked at least after every 10 hours of use. Add grease if the joints have become dirty. Adequate lubrication of the joints must be ensured. Lack of lubrication will cause the joints to wear quickly.

Use general purpose machine grease. A grease gun is needed to apply grease to grease nipples. All lubrication nipples are standard R1/8" nipples. Replace any damaged nipples.

Clean the end of the nipple before greasing and add only a small amount of grease at a time. New lubricant will push out dirt from joints. Wipe excess grease with a cloth.

Add grease to lubrication points of the telescopic boom (4) when the telescopic boom has been fully retracted.

Greasing points are listed in the following table.

Reference		Number of points
A	1. Articulation joint Left side of loader	2
	2. Steering cylinder Both ends of steering cylinder, near articulation joint	2
B	3. Boom pivot pin Both ends of boom pivot	2
	4. Lift cylinder	2
	5. Levelling cylinder If fitted. Lower end accessible under front cover.	2
C	6. Telescopic boom Grease when boom is completely retracted	2
D	7. Tilt cylinder	2
	8. Attachment coupling plate Pivot pins and tilting mechanism	5

A. Articulation joint and steering cylinder

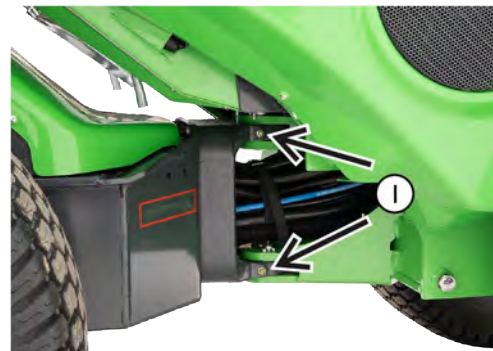



B. Front frame and telescopic boom

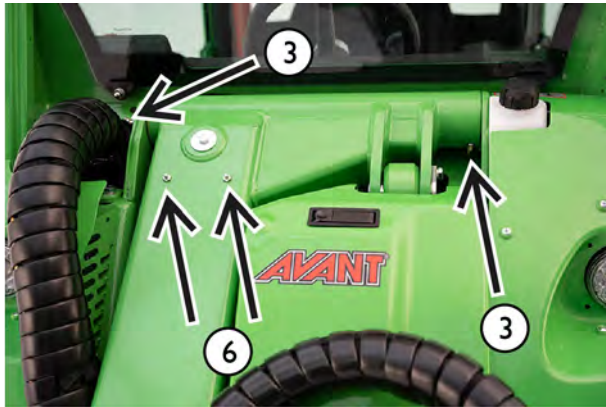

C. Cylinders and coupling plate



5. Check the boom, pivot pins, and other metal structures visually

Check the loader structures visually. Do not use the loader if there is visible damage, signs of bending, ruptures, cracks, or buckling.

- All pivot pins must be in good condition and secured in place.

Make sure that the pivot pins are not worn and there is no excessive slack in the joints. Worn pins lead to wear and failure of the joints, only small slack is acceptable.

- The telescopic boom has slide pads that wear during use. The telescopic inner part of the boom must not move significantly when manually handling it. If it is necessary to adjust or to replace the slide pads, see page 129.
- Check the steering cylinder, its pivot pins, hydraulic fittings, and brackets connecting the cylinder to the front and rear frames.



Risk of dropping of load - Check all pivot pins. Check the tightness of the locking screws of all pivot pins. Also check the pivot pin connecting the boom to the front frame. If any of them is loose, use thread locking compound and tighten.



Risk of serious injuries - Discontinue the use of the loader and contact Avant service in case the steel structure of the loader gets damaged. A faulty reparation, or wrong methods and materials used for reparation, can cause hazardous failures or further damage the loader.

**WARNING**

Damaged or modified safety structures do not protect in same way as original ones. In case the ROPS safety frame or the FOPS canopy of the machine gets damaged, the machine must be taken to Avant service for checking. It is not allowed to repair the ROPS and FOPS.

6. Check tightness of bolts, nuts, and fittings

Check tightness of bolts, nuts, and hydraulic fittings regularly. Check visible bolts and hydraulic fittings visually daily. Check bolts and fittings more thoroughly as part of periodic maintenance. Do not start the loader if any bolt, pivot pin, or hydraulic fitting is loose, damaged, or missing.

Check pivot pins

Check the pivot pins and the tightness of the locking screws that lock the pivot pins:

- pins connecting the articulated frames
- pins connecting the steering cylinder
- pin connecting the boom to the front frame
- all pins of the boom and its cylinders

If any pivot pin locking bolt is loose, apply thread locker compound and tighten the bolt.

**WARNING**

Risk of dropping of load - Check all pivot pins. Check the tightness of the locking screws of all pivot pins. Also check the pivot pin connecting the boom to the front frame. If any of them is loose, use thread locking compound and tighten.

Check wheel nuts

Check tightening of the wheel nuts with a torque wrench. Wheel nuts must be tightened to 225 - 275 Nm. The wheels and nuts settle in after first few hours of use, check the tightness after five hours of use.

NOTICE

Tighten wheel nuts after first five operating hours. Check tightness of wheel nuts regularly.

Other bolts and nuts

Bolts and nuts on the loader are standard metric system type. If replacement of bolt or nut is necessary, replace both at the same time with ones that are identical in size and grade.

Most bolts and nuts on the loader are metric grade 8.8. See the spare parts catalog for information about bolts, nuts, and washers. Contact Avant service if you are unsure of suitable fasteners.

- Check the bolts connecting the rear frame extension to the rear frame. These bolts must be tightened to 227 Nm. These bolts must be grade 10.9.
- Check the fastening of the drive motors. For more information see page 130.

These bolts must be checked after the first 50 hours of service, and then after every 400 hours or 1 year of use, whichever comes first.

Check hydraulic fittings

Check hoses and fittings visible on the loader boom. Push and pull the hoses manually and look if any fitting is loose.

Do not overtighten hydraulic fittings. Tighten any hydraulic fitting only if there are signs of leakage or loose connection. Tightening of a hydraulic fitting unnecessarily can damage it.

Make sure that replacement hoses and fittings meet the ratings and specifications of the original hoses, and are compatible with the fittings on the loader. Contact Avant service when hoses or fittings need to be replaced.

Hydraulic fittings of drive motors and hoses of drive system

Hydraulic fittings of the drive system are equipped with a visible marker where a yellow marker is fully visible, when the fitting is tightened correctly. If a hose or fitting needs to be replaced, use only hoses which are equipped with compatible fittings.

Reuse of hydraulic hoses or fittings

Never reuse pressed fittings that are part of hydraulic hoses. If a hose must be replaced, it must always be equipped with new fittings. Use only high-quality hoses and fittings. Hoses must be made with professionally made pressed fittings. Do not use reusable hose fittings.

Tapered JIC-type hydraulic fittings may get damaged when removed and re-tightened. Note that JIC type fittings are not tightened with torque and fitting will break when tightened too much.

7. Check wheels

Check the condition of tyres and rims visually daily. Do not use if there is visible damage on tyres or rims. If a tyre is punctured take the tyre to a professional tyre shop. It may not be possible to repair all punctures safely. Do not repair tyres yourself.

Check tyre pressure with a pressure gauge whenever you suspect wrong pressure. Check the tyre pressures at least monthly. Check tyre pressure when heavy attachments and extra counterweights are not attached.

Check that the tyre models are appropriate for the loader model and listed on page 39. The load and speed rating of the tyre and rim must be appropriate for the loader model.

The correct tyre pressure depends on tyre model and intended load. Refer to Chapter Technical Specifications.



WARNING

Risk of loss of stability due to tyre failure - Never attempt to repair a tyre by yourself. The loader is equipped with heavy duty tyres that must only be repaired by a qualified tyre technician.

8. Check the attachment and the quick coupling plate

Check the locking of attachment and locking pins on attachment coupling plate. Check both locking pins:

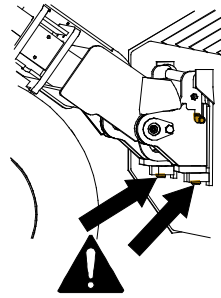

- Both pins must move easily and come through the lower brackets of the attachment.
- To check the attachment and any additional coupling instructions for individual attachments, see the Operator's Manual of the corresponding attachment.

The locking pins must return easily to their locking position. Do not operate the loader if the coupling pins do not lock down.

Clean the locking pins when cleaning the loader. Move the locking pins regularly, even if you do not change attachments regularly.

The quick coupling plate and its pin on top of it must not be bent, cracked, or otherwise damaged.

Make sure that the attachment is locked if an attachment is mounted on the quick coupling plate. Check the operation of the attachment, and position of the hydraulic hoses of the attachment. Hoses must not rub against sharp surfaces or get stretched or pinned when moving the loader boom and the attachment.

Hydraulic attachment locking:

If your loader is equipped with hydraulic attachment locking, check that both locking pins move up and lower down completely by using the switch on the dashboard. Do not operate the loader if the attachment locking system pins do not lower down completely.

Use the hydraulic locking periodically even if you do not change attachments.

9. Check hydraulic oil level

Check the level of hydraulic oil with the dipstick of the filler cap. Remove the front panel to access the filler. Keep the loader boom completely lowered.

Check level of hydraulic oil especially after using a new attachment that drains hydraulic oil from the loader as the hydraulic system of the attachment fills up. Check also if you have noticed a leak of hydraulic oil.

Oil level should be approximately at the lower mark of the dipstick (1) when the loader boom is up.

Tighten the dipstick on its threads for measurement. Refill, when necessary, but never exceed the upper limit mark (2). Doing so can cause oil to overflow when lowering the boom.

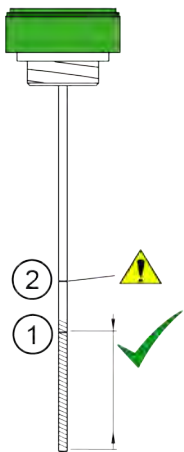

1. Target marker. Fill to this mark when hydraulic system is **cold**.

The area highlighted in the adjacent figure shows approximately the acceptable level.

2. The second mark on the dipstick indicates max level of hydraulic oil. Oil can reach this level when hydraulic system is **hot**.

Never overfill the hydraulic oil tank. Oil can flow over, or foam inside tank.

Inspections after starting the loader

10. Test the movements of boom

- The boom should move smoothly to all extreme positions, when using it without an attachment.
- If the telescopic function of the boom starts to stick under load, add grease to the lubrication points on top of the boom. Do not apply grease directly on the inner boom as it will collect dirt and cause wear. Extend the boom fully and spray PTFE lubricant onto the inner boom.
- If the wear pads are worn, there may be too much play between the boom sections. If there is noticeable play, adjust or replace the slide pads of the boom.
- If an attachment is fitted, check that the boom moves smoothly within its normal operating range.

Hydraulic hoses or electric cables must not get pinched or stretched in any position of the boom



CAUTION

Risk of collision - Avoid moving the attachment to a position where it can contact the loader.

Some attachments may reach the front tyres, boom, or structures of the loader when moving the boom or tilting to the extreme positions. Use any attachment only for its intended use.

11. Test drive control and steering

- Check operation of pedals and steering. Pedals must move freely and not get stuck or feel stiff.
- Check that loader stops when not pressing the drive pedals. Do not use the loader if the braking performance is decreased, or if the loader creeps.
- Allow the loader to warm up and check steering. When the engine is running, turning the steering wheel should be easy. When the engine is off the steering will work but it will need more effort. There is a built-in backup steering that makes it possible to turn the loader in case the hydraulic flow to steering is interrupted.

If you notice any trouble with pedals, stopping of the loader, creeping, or trouble with normal or back-up steering, switch on the parking brake, shut down the loader, and service the loader before continuing use.

12. Test parking brake

Test the parking brake periodically.

1. When the loader is running, switch on the parking brake.
2. Switch drive speed mode to slow.
3. Press drive pedals. The loader must not move when parking brake is on.
4. Increase engine RPM and test the parking brake to both front and rear directions.

If the loader moves when drive pedals are pressed, stop using the loader. Service the brakes before using the loader.

Periodic service

These maintenance and service procedures may require special equipment, tools, or skills. They are recommended only for professional service technicians.

Periodic service includes all the maintenance tasks shown in this Operator's Manual in addition to the service tasks listed in this section of this Operator's Manual.

Contact your Avant dealer to locate your nearest Avant service.

1. Change hydraulic oil

When changing hydraulic oil, the oil can be removed with a suction pump or by opening the drain plug on the right side of the front frame, next to the articulation joint. In both cases it is important to clean the magnetic drain plug. Hydraulic oil tank capacity is 38 l.

Hydraulic oil type

Always use correct type of clean, high-quality hydraulic oil with extra lubrication additives. Recommended oil types are:

- ISO VG-46 certified mineral oil
- Mobil SHC™ Hydraulic EAL biodegradable mineral oil based hydraulic oil

Check the label on the loader for information which oil has been added in factory.

If ambient temperature is hot, higher viscosity oil may be required. Contact your Avant dealer or authorised service.

In freezing temperatures use high-quality oil which has wide viscosity index, and which is also intended to be used in cold temperatures. Correct type of oil makes cold starting easier and improves the performance of the loader in cold temperatures.

NOTICE

Use of synthetic oils, or use of other types of bio hydraulic fluids than listed above, may cause premature wear or damage to the hydraulic components and is not permitted. Using wrong type of hydraulic oil will void the warranty.

NOTICE

Never use plant-based bio oils. Only the bio oil type shown above is approved for use. It ensures wear resistance and performance of the hydraulic system. Only this oil can be added without flushing the hydraulic oil circuits. Handle waste bio oil as normal waste oil. Never leave any oils into environment. Always dispose of hydraulic oil following local regulations.

2. Change hydraulic oil filter

The loader is equipped with a hydraulic oil return filter. It is located on top of the hydraulic tank, next to the dipstick. Take off the cover and replace the oil filter cartridge. Dispose used filters as instructed by your local authorities. Never throw used oil filters in trash.

Hydraulic oil return filter:

- Located on top of the hydraulic tank, under the front cover. Take off the cover and replace the oil filter cartridge.



3. Clean or replace hydraulic oil tank breather

There is a breather filter inside the dipstick cap which must be cleaned or changed once a year. Breather filter product code is A429562.

4. Check battery and cables visually

Battery

The battery cells are mechanically protected against damage by the outer shell of the battery, but in severe accidents cells inside of the battery might be deformed. Check the outer surfaces of the battery for signs of dents, deep scratches, cracks, and corrosion. Discontinue use of the battery if there are signs of mechanical damage on it.

Mechanically damaged batteries must not be left unattended as they may self-ignite. In case a battery is mechanically damaged, contact Avant dealer or Service Point. See pages 21 and 22 for information about potential fire hazard.

Cables and insulators

Check the battery, all cables, and insulators visually for signs of dirt and mechanical damage. Make sure all cables are routed and fastened in a way that prevents them from becoming chafed during use of the loader. If there are signs of wear on any cable or insulator, prevent further damage to the cables and service the loader before continuing use.

5. Check hydraulic hoses, fittings, and other hydraulic components

Check the positioning and routing of the hydraulic hoses. The outer layer of any hydraulic hose must not be damaged so that any inner layer is visible. Replace hoses that show signs of damage.

Move the hoses manually and see if the fittings of the hoses are loose. Check if hydraulic fittings show signs of leakage.

Hydraulic hoses age over time. Exposure to sunlight can accelerate aging of the hoses. Replace any hose that has cracks on its surface when you bend the hose.

6. Check pressure of hydraulic system

It is recommended to leave the measurement and adjustment of hydraulic pressures to qualified service technicians. At minimum, a hydraulic pressure gauge with appropriate measurement scale and fittings are required to complete the measurement.

The specified pressures for each hydraulic circuit must not be exceeded. Wrongly made adjustment can cause significant damage to the hydraulic components of the loader, and to the metal structures of the loader. Also attachments may get damaged.

The main pressure relief valve for the auxiliary hydraulics pump is located on a valve block at the rear frame of the loader. However, the pressure of the boom and auxiliary hydraulics is adjusted from the boom control valve. The main pressure relief valve must never be adjusted. If boom pressure can't be adjusted high enough from the boom control valve, the pump and main relief valve must be checked. Contact Avant service.



Risk of injection of hydraulic oil
- **Wrong handling of the hydraulic system or wrong tools can cause ejection of hydraulic oil.** It is recommended that pressures should only be checked or adjusted by a competent and experienced technician. Contact your Avant dealer if you need assistance.

Pressure measurement from multiconnector

To measure the pressure of the auxiliary hydraulics, it is recommended to use the pressure gauge adapter A422475.



Layout of the control valve

Boom and auxiliary hydraulics pressure relief valve (1) is located in the control valve assembly.

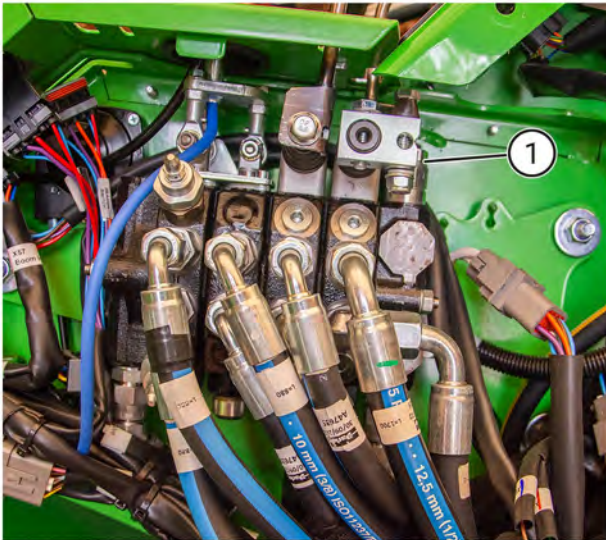

NOTICE

Never adjust pressure to higher level than recommended setting. The electric drive system is designed to operate at the intended pressure level. Other settings can damage electric drive, modify the response of the controls, and decrease battery life. Warranty will not cover for damages caused by wrong pressure setting. Never remove tamper resistant seals from pressure relief valves.

Drive pressure check

Drive pressure cannot be checked by user. Drive pressure must be checked only by qualified service technicians. If you suspect that the pulling force of the loader has decreased contact your nearest Avant service. Also the power control valve, the hydraulic drive motors, drive pump feed pressure, and brake release pressure must be checked when investigating drive system related troubles. There are two pressure relief cartridges which have fixed pressure setting, there are no adjustable settings.

NOTICE

Checks and measurements related to the hydrostatic drive system are recommended only for experienced service professionals. Special instruments are required.

7. Adjust pressure of hydraulic system

If the pressure check of boom and auxiliary hydraulic systems indicates that the pressure is wrong, contact Avant service. Wrong adjustment can damage the pump or motor.



Never exceed the recommended hydraulic pressure settings. Excessive hydraulic pressure may lead to hydraulic oil ejection by hose burst or component failure. Wrong adjustment will damage or wear the hydraulic pumps, cylinders, and hydraulic motors. Warranty does not cover damages caused by excessive hydraulic pressure.

Drive pressure:

Cannot be adjusted by user. If the pressures are clearly wrong, the pressure relief cartridges with fixed pressure setting must be replaced. Contact service for correct parts.

8. Check and adjust slide pads of telescopic boom, replace if necessary

The telescopic boom is equipped with replaceable slide pads. The slide pads are parts that wear during normal use of the telescopic function. All slide pads can be replaced, and the nylon slide pads on the outer boom can also be adjusted. Adjustment or replacement of the slide pads is necessary to compensate for wear and to adjust the play between the outer and inner telescopic boom.

- At the lower end of the outer boom there are pairs of nylon slide pads 1 and 2, accessible from around the boom.
- In addition, there are pairs of aluminium-bronze alloy slide pads 3 and 4, at the upper end of the inner boom. To access pads 3 and 4, the inner boom must be separated from the outer boom. Lifting equipment is needed to complete this. It is recommended to leave the check and replacement of slide pads of the inner boom to professional service.

Slide pads 1 and 2

Slide pads 1 and 2 can be adjusted by mounting thin adjustment sheets between the boom and the slide pad.

Fully extend the telescope and press the boom gently against the ground. This way it is the easiest to mount an adjustment sheet under lower slide pad 1.

However, if there is substantial wear in the slide pads it is advisable to replace both pads 1.

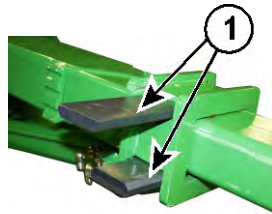

Slide pads 3 and 4

Slide pads 3 and 4 at the upper end of the inner boom last long in normal use. They should be checked after every 400 operating hours and replaced at least after 800 hours of use.

To check these slide pads, take the inner boom completely out of the outer boom. If the pads have worn so much that they are in level with the boom, or excessive boom play cannot be removed by adjusting slide pads 1 and 2, replace all slide pads.

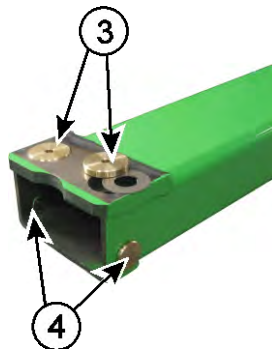

NOTICE

To replace slide pads 3 and 4 the boom must be partially disassembled. Lifting equipment is required in order to do the service safely. It is recommended to leave this service operation to your nearest Avant service partner.

Slide pad part numbers	
Slide pad 4	A48343

9. Check mounting and operation of drive motors

Check the tightness of the drive motor fastening bolts. The bolts must be tightened to 200 Nm.

Test the functionality of the drive motors by pushing against a fixed structure, or a pile of sand, for example. All four wheels should spin.

10. Check the safety frame, seat, seat belt, lamps, and other safety related equipment

If any of part of the loader has been damaged or is otherwise faulty, it must be repaired or replaced before continuing to use the loader.

Check, test, and, if necessary, clean all safety related equipment of the loader.

- Check the ROPS and FOPS structures for visible damages. If ROPS or FOPS is damaged, they must be replaced with new ones.
- Check the installation, condition, and adjustments of the seat.
 - Make sure the suspension system works and that it can be adjusted.
 - Test all adjustments. Check that all seat adjustments work and lock into the selected setting.
 - Clean the surface of the seat with appropriate cleaning supplies.
- Check and test the seat belt.
 - Make sure the buckle locks firmly and can be released easily.
 - Test the reeling of the seat belt, the belt must reel in completely, and it must lock instantly when pulling the belt quickly.
 - Clean the seat belt with damp cloth and mild soap.
- Test all lamps and lighting devices. If the loader is equipped with road traffic light kit, check the alignment of the headlights. Check and clean all reflecting parts.

Slide pad part numbers	
Slide pad kit: Includes Slide pads 1 and 2 and adjustment sheets for pads 1 and 2.	A430743
Slide pad 3	A47922
Spacer under slide pad 3	A47941

- Check the grip surfaces on the floor of the loader and on the access steps. Clean the surfaces and replace grip surfaces if necessary.
- Check that the boom service support and the frame lock are stored in their place and that they have the necessary locking parts.
- Test the function of the reverse buzzer, if installed on the loader.

Check and test all control levers, switches, and equipment of the loader

Perform these checks in addition to those checks that are stated elsewhere in this manual.

- Check that the boom control lever returns to its center position when released. Check that the lever feels firm and there is no play in its mechanism.
- Check that auxiliary hydraulics control lever returns to its middle position when released. Check that its locking plate is adjusted correctly.
- Check that telescopic boom control lever returns to its middle position when release

Check optional equipment

Check function and condition of optional equipment that has been installed to the loader:

- Functionality of Opticontrol
- Functionality of Anti-slip valve
- Functionality of Boom floating
- Reverse beeper
- Road traffic lights.

If the loader is equipped with a cab:

- Check the condition of the windscreen. Cracked or worn windscreen must be replaced.
- Check condition of other window panels. Damaged panels must be replaced or removed completely.
- Check that the windscreen wiper and washer work. Change wiper if it is worn or damaged.
- Check the emergency window hammer and marking of the emergency exit. Make sure a hammer is available and usable for emergency situations.

11. Service the hydraulic attachment locking (option)

Check the correct locking of the attachment daily before starting to use the loader and its attachments. Both locking pins must lower easily completely down, through the holes of the brackets of an attachment.

If the locking pins do not lower completely down stop using the loader and do service for the quick coupling plate.

Remove the cover panels on front of the quick coupling plate. Clean the cavities around the locking pins and the hydraulic cylinder and its linkage. Use dry lubricant such as PTFE.

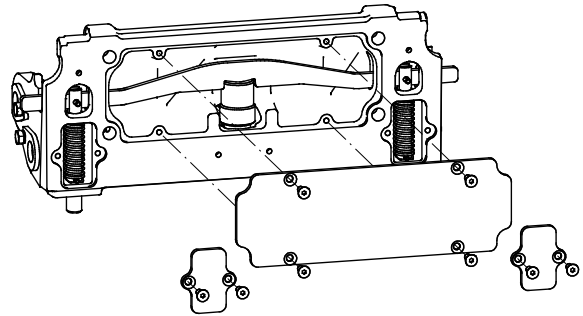

12. Check articulation joint

Check for excessive play and ensure proper lubrication

Check the articulation joint at the first 50 hour service, and then at least after every 400 hours of use or annually. If there is play in the joint, the joint must be serviced to prevent severe damage of the joint.

If there is play in the joint and it is not repaired in due time, the play will increase rapidly, causing severe damage to the front and rear frames. Wear can be slowed with proper lubrication and by removing play if these actions are made in early stages. Contact Avant service if there is play in the articulation joint.

Wear of the articulation joint is usually caused by lack of lubrication. Keep the loader clean and ensure adequate lubrication of the articulation joint.

Check tightness of bolts

The articulation joint is fastened to the rear frame with a series of M12 Allen bolts. Check the tightness of the bolts after the first 50 hours of use and then after every 400 hours, or annually.

The bolts of the articulation joint must be tightened to 136 Nm.

13. Reset service reminder

Reset the service reminder from the multi-function display after the periodic service has been made completely. Make sure that all periodic maintenance and service tasks have been completed before resetting. Fill in details of service to the maintenance log in this manual.

Check or change OptiTemp fluid

The OptiTemp[®] fluid must be checked after 5 years of use. Avant service will check and determine if the fluid must be changed due to accumulation of water into the fluid. Never attempt to change the fluid by yourself.

Filters - list of filters

Avant e513/e527

Filter	
Hydraulic oil return filter	74093

Electric system & fuses

This chapter of this manual deals with the 12 V systems of the loader. Fuses related to the battery, or other above 12 V systems are not serviceable by users.

Fuses

Locations of the fuse boxes are shown in this chapter. In the event of electric malfunction, always check the fuses first. If a fuse blows again after replacing it, search for cause of burning before replacing the fuse again. The electric cables or other electric parts may be damaged causing a risk of fire. Electric cables may be damaged. Contact Avant service, if necessary.





If any of fuse or relay needs to be replaced, make sure to always use correct type of spare parts. Always use fuses and relays with correct rating. Wrong types of fuses or relays can cause risk of fire or damage to wiring or other electric components.

Fuse box for options and controls





An easily accessible fuse box is located under the front panel next to the boom.



12 V Fuse box 1

1	F1 25A  H	Hydraulic oil cooler fan fuse
2	F2 10A 	Dashboard Control systems
3	F3 10A 	Lights, horn
4	F4 10A 	Smooth drive
5	F5 15A EXTRA 2 1	Extra work lights Auxiliary hydraulics extra outlet
6	F6 20A 	Joystick Seat heater (if installed)

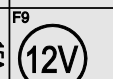
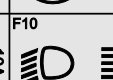
12 V Fuse box 2

1	F7 10A 	Lights Road traffic lights, continuous
2	F8 5A 	Warning beacon
3	F9 15A 	12 V electric outlet
4	F10 10A 	Lights Road traffic lights
5	F11 30A 	Opticontrol
6	F12 10A 	Windscreen washer and wiper

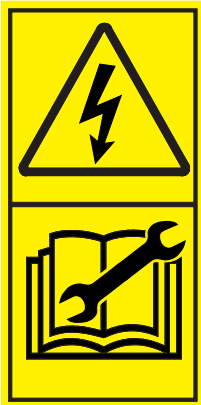
**WARNING**

Risk of high-current electric shock, fire, and explosion of battery - Never repair or modify the 48 V electric system. If a fuse related to the electric motors and their control systems is blown, it is an indication of more serious fault on the electric system. Contact service. Contact with high-current parts of the electric system can cause a potentially lethal electric shock, regardless of the relatively low voltage. Contact authorized service in case of trouble with the electric drive system.

Automatic main switches

There are two independent main switches on the loader, which are both automatically operated.

The BMS and other control electronics control the output of the battery.

The 12 V output from the lithium-ion battery is activated with the ignition switch.

If the loader is equipped with the auxiliary 12 V battery, it is always on to power i.e. road traffic light kit.

Main fuses

The main fuses of the electric drive system are located on the EMI filter. If the loader does not respond to ignition switch, check the fuses visible on this circuit board:

- 3 pcs 58 V / 7,5 A fuses
- 1 pc 58 V / 15 A fuse

On the high current feed cable to the inverters is a 500 A main fuse. On inverters there is a 250 A fuse on one of the inverters and 425 A fuse on the other. If a fuse related to the electric motors and their control systems is blown, it is usually an indication of a more serious fault on the electric system. Contact service.

Contact with high-current parts of the electric system can cause a potentially lethal electric shock, regardless of the relatively low voltage. Contact authorized service in case of trouble with the electric drive system.

Relays

Relays are installed under the front center panel next to the boom. The number and function of installed relays depends on installed options and equipment on the loader. In case of trouble related to the electric function, and the fuse is not blown, check the relays.

Relays under the front panel:



Electro Magnetic Interference (EMI) - filter

The EMI filter acts as a junction box for high power cables and 12 V system. The EMI-filter is located at the right side of the motor and battery compartment.

There are additional fuses and relays in the EMI-filter. Make sure that other fuses of the loader are intact before opening fuse box of the EMI-filter. Never open the cover panel of the EMI filter housing since there are no serviceable parts inside the housing.

Check that all cables are tightened. If any cable is loose, use a torque wrench to tighten the connectors (M6 to 8 Nm; M8 to 11 Nm).

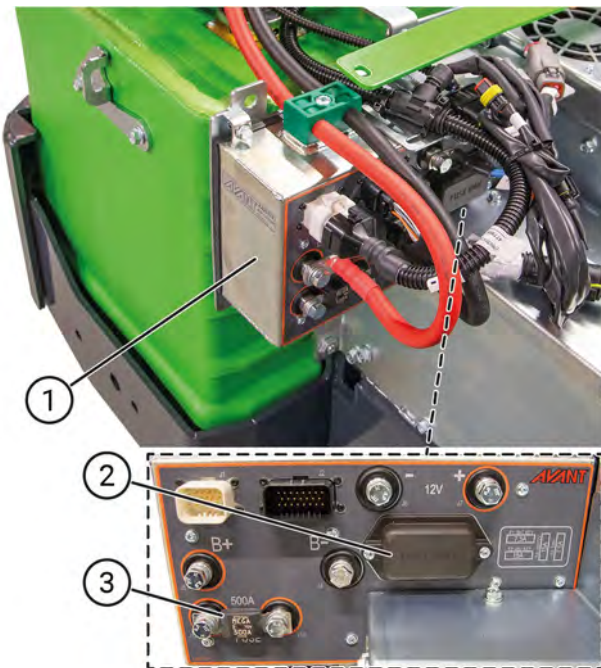

- 1. EMI-filter
- 2. Fuse box of the EMI-filter
- 3. Main fuse.

NOTICE

Always switch off the loader before accessing the fuses on the EMI. Also, wipe the cover and its surrounding clean from dust and moisture before opening it. Make sure the seal is clean and fits perfectly when closing the cover.



Potentially hazardous electric current. Make sure the loader is switched OFF before accessing the EMI filter.

Auxiliary power and jump start

The loader can't be switched on with external power sources. If the lithium battery is completely empty, or the loader does not respond to the ignition key, contact Avant service.

Never use the loader to jump-start other equipment. The 12 V power supply of the loader is neither strong enough or intended for powering any other equipment.

Replacing battery pack

Battery can be replaced only by Authorized service. Replacing the battery pack requires special tools and equipment. For the battery to operate correctly, battery and loader software parameters must be adjusted.

To remove the battery from the loader due to damage or for recycling, use the lifting points on the sides of the battery pack. Use lifting equipment that is capable of lifting the entire battery pack.

The battery must be removed and handled as a complete assembly. Never open or disassemble the battery. There are no user replaceable parts inside the battery. Lifting lugs are shown in the following figure.

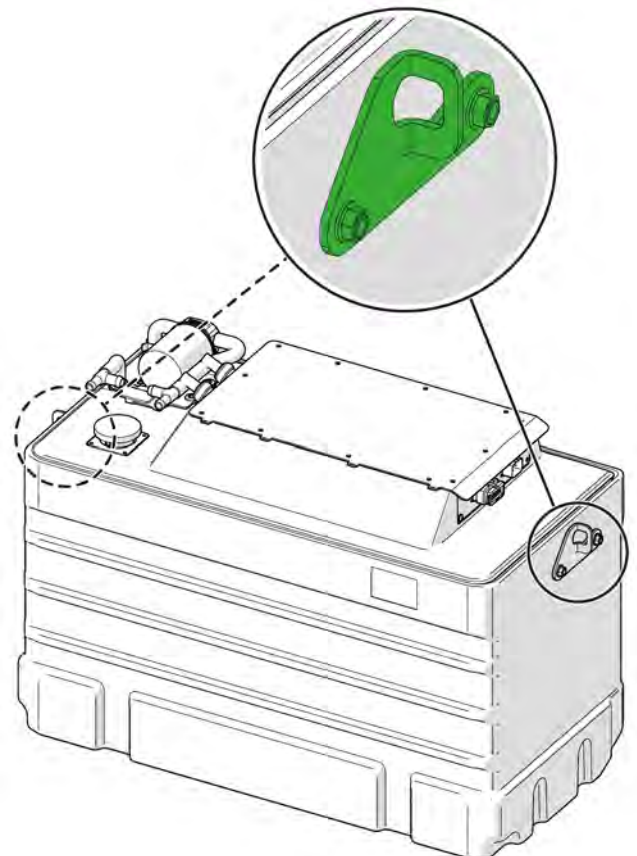

Handling and recycling of used batteries

Used batteries must be treated hazardous waste and must be disposed of properly. Used Lithium-ion batteries must be recycled according to country specific legislation. For recycling please return the used battery to your Avant dealer or Service point. For more information about Avant dealers and Service points please visit www.avantteco.com.

Metal structures of the loader



Risk of serious injuries - Discontinue the use of the loader and contact Avant service in case the steel structure of the loader gets damaged. A faulty reparation, or wrong methods and materials used for reparation, can cause hazardous failures or further damage the loader.



Damaged or modified safety structures do not protect in same way as original ones. In case the ROPS safety frame or the FOPS canopy of the machine gets damaged, the machine must be taken to Avant service for checking. It is not allowed to repair the ROPS and FOPS.

End of life disposal

When the loader is at the end of its useful life recycle and dispose of the loader properly. Drain and collect all fluids and handle following the current local regulations. Dismantle the loader and separate the different materials, such as plastic, steel, and rubber, and recycle each material. Never leave fluids or material in the environment.

The Lithium-ion battery of the loader must be recycled correctly. Contact your Avant dealer for more information about proper handling of a used battery.

Troubleshooting

Listed below are possible causes for typical problems and suggested remedies. In case you experience trouble with the operation of the loader, check troubleshoot lists first. If problem is not solved, contact your nearest Avant service point or dealer.

Problem	Possible cause	Remedy
Drive pedals do not respond.	Operating mode that prevents the use of the drive pedals is selected.	Use the operating mode switch to choose a mode which allows the use of the drive pedals. See page 63.
Electric motors won't start when turning the ignition switch.	Operator is not seated on driver's seat.	Operator must sit on driver's seat in order to use the controls of the loader. Also, other operating mode can be selected to operate certain attachments from another control position, see page 63.
	Ignition switch fuse is blown.	The ignition switch controls also the electric main switch of the loader. There are two fuses for the ignition switch. Check all fuses, see page 134.
Hydraulic attachment does not work when the auxiliary hydraulics control lever is moved.	Attachment hoses are not coupled or the multi connector is not fully locked.	Make sure that the multi connector is properly connected.
	Quick couplers are faulty or damaged (will restrict or stop oil flow).	Replace quick couplers in multi connector.
	Operator is not seated on driver's seat.	Operator must sit on driver's seat to activate auxiliary hydraulics. Also, other operating mode can be selected to operate certain attachments from another control position, see page 63.
	Attachment has fault.	Check functionality with another attachment, if possible.
Attachment hoses do not go into the extra front or rear quick couplers of the loader.	There is back pressure in the auxiliary hydraulics line.	Release the pressure by moving the extra auxiliary hydraulics control lever in both directions.
Hydraulic oil overheats.	Control valve is not fully open.	Adjust the locking plate of the auxiliary hydraulics control lever, see page 59.
	Hydraulic oil cooler is dirty, blocked or faulty.	Clean hydraulic oil cooler and check that fan is clean. Check fan fuse, temperature switch and relay.
	Hydraulic system is overloaded.	Allow loader to cool down by leaving on idle until hydraulic oil cooler stops. Avoid operating an attachment at extreme load continuously. Make sure that attachment is operated correctly. Make sure that flow restrictors are not left half open on hydraulic circuit.
	Hydraulic oil level is too low.	Make sure that hydraulic oil level is as shown on page 125.
Electric motors do not run.	Battery is discharged or damaged.	Charge battery. Check battery condition. Contact Avant service if battery is visibly damaged.
	Operator is not seated on driver's seat.	Operator must sit on driver's seat to activate auxiliary hydraulics. Also, other operating mode can be selected to operate certain attachments from another control position, see page 63.
	Auxiliary hydraulics control lever is in locked position.	Release the lever to neutral position.
	Fuse is blown.	Check all fuses.
	Temperature is too low.	The current output capacity of the battery is reduced in extreme cold. Also, hydraulic oil becomes thick (viscous) in cold. Combined with low charge level the hydraulic motors may not start running. Take the loader to warm place to heat, and charge battery. Use high-quality hydraulic oil.

Problem	Possible cause	Remedy
Drive works erratically and boom movements do not work at all, electric motors run	Low hydraulic oil level	Check hydraulic oil level and condition.
Drive and boom movements work erratically, motors run smoothly	Air in hydraulic components	Move boom and steering cylinders and hold at each extreme position to de-air the system. Check hydraulic oil level and condition.
Hydraulic oil pushed out from hydraulic oil filler cap, hydraulic oil foams	Leak in hydraulic suction line connecting tank and hydraulic pumps allows air to sucked in	Replace suction hoses.

Maintenance log

1. Customer _____
2. Loader model _____ Serial number _____
3. Date of delivery _____

Date of service dd / mm / yyyy	Operating hours	Remarks	Serviced by: Stamp/signature
___/___/___	____/ 50 h		
___/___/___	____/ 450 h		
___/___/___	____/ 850 h		
___/___/___	____/ 1250 h		
___/___/___	____/ 1650 h		
___/___/___	____/ 2050 h		
___/___/___	____/ 2450 h		
___/___/___	____/ 2850 h		
___/___/___	____/ 3250 h		
___/___/___	____/ 3650 h		
___/___/___	____/ 4050 h		

Notes

Index

A

- Access to battery and electric motor compartment • 114
- Add grease to the lubricating points • 121
- Adding or removing counterweights • 66, 67
- Adjust pressure of hydraulic system • 129
- Allow the loader to warm up properly • 83
- Attachment control switch pack for rear mounted attachments (option) • 63
- Auxiliary hydraulics oil flow • 37, 41, 60, 63, 88, 92
- Auxiliary power and jump start • 135
- Availability of options • 7
- Avant warranty • 8

B

- Ballasted tyres • 41
- Battery and Charging • 102
- Battery safety • 12
- Battery specifications • 25, 26, 38
- Battery system in cold environment • 83
- Before start • 77
- Boom floating (option) • 52, 64
- Boom self-levelling (option) • 65

C

- Cab Safety • 74
- Cabs (option) • 73
- Change hydraulic oil • 127
- Change hydraulic oil filter • 127
- Charge process • 106
- Charge times • 103
- Charging the battery • 105
- Check and adjust slide pads of telescopic boom, replace if necessary • 122, 129
- Check articulation joint • 131
- Check battery and cables visually • 128

Check hydraulic hoses, fittings, and other hydraulic components • 128

Check hydraulic oil level • 125

Check mounting and operation of drive motors • 123, 130

Check or change OptiTemp fluid • 132

Check pressure of hydraulic system • 128

Check the attachment and the quick coupling plate • 124

Check the boom, pivot pins, and other metal structures visually • 119, 122

Check the general condition of the loader • 119

Check the safety frame, seat, seat belt, lamps, and other safety related equipment • 130

Check tightness of bolts, nuts, and fittings • 123

Check wheels • 124

Clean or replace hydraulic oil tank breather • 127

Clean the loader • 119

Connecting the hydraulic hoses of the attachment • 91

Connectivity and collection of data • 5

Control lever of auxiliary hydraulics (hydraulically operated attachments) • 59, 69, 78, 92, 138

Control lever of boom and bucket • 51, 59

Control of loader boom, auxiliary hydraulics and other functions • 59

Controls and options of the Loader • 50

Counterweights • 13, 15, 66

Coupling adapters • 94

Coupling the attachments • 89

D

Daily and weekly maintenance • 21, 119

Daily inspections and periodic service schedule • 116

Daily maintenance and inspections • 77, 79, 117

Dashboard • 53

Definitions • 37, 44

Description of the loader • 24

Diagnostics port • 51, 64

Dimensions • 36

Drive control • 80

Drive or use while charging • 104

Drive pedals • 51, 80

Drive speed and pulling force • 40

Drive speed range selection switch • 52, 55, 80, 81, 83

E

Electric 12 V outlet • 51, 64

Electric qualification • 7

Electric system & fuses • 133

Electric systems of the loader • 19

Electric systems of the loader and battery pack - Safety • 19

Electro Magnetic Interference (EMI) -filter • 135

Emergency stop button • 63, 78

End of life disposal • 136

Ensure battery charge level • 119

External rapid charger • 109

Extra auxiliary hydraulics coupling • 93

Extra auxiliary hydraulics outlets, front and rear (option) • 52, 69

Extra work light kit (option) • 52, 71

F

Falling objects protection system (FOPS) • 17

Filters - list of filters • 132

Fire prevention • 21, 128

Follow correct charging procedure • 104

Foreword • 3

Fuses • 133

G

General information • 36, 37

General safety instructions • 9

H

Handle battery with care • 20

Handling of heavy loads • 13, 85

Hazardous areas around the loader • 12

Headlight, beacon, blinker & reflector kit (option) • 71

Height and width • 36

How to estimate actual lifting capacity • 49

How to use an external charger • 110

Hydraulic attachment coupling • 52, 90

Hydraulic oil type • 127

I

Identification of the loader • 24

Ignition key • 51, 77

In case of fire • 22

In case the loader tips over • 86

Inspections after starting the loader • 126

Installing of service support and frame lock • 115

Intended use • 5

Introduction • 3

J

Joystick - 6 function (option) • 61

K

Keep this manual with the loader • 7

L

Leaving the charger plugged • 104

Lever for pump RPM control • 41, 51, 60, 83

Lift capacity • 13, 15, 43, 48, 60

Lifting of the loader • 100

Light control switch (road traffic light kit) • 71

Lights • 71

Load charts • 45

Load charts of other attachments • 45

M

Main parts of the loader • 26

Maintenance log • 116, 141

Make sure all relevant manuals are available • 4

Material handling • 43, 60, 85

Metal structures of the loader • 136

Mirrors • 72

Modifications • 17

Multi-function display • 51, 54

N

Notes • 142, 143

O

Operating and storage temperatures • 6, 103, 104, 119

Operating instructions • 76

Operating time • 103

Operation in cold conditions • 83

Operation on uneven surfaces, gradients, and near excavations • 14

Operator qualification • 7

Opticontrol® • 52, 62

OptiDrive® • 81

Overview of controls • 51

P

Parking brake switch • 52, 61

Periodic service • 127

Personal safety and protective equipment • 16

PTO switch • 53, 60, 63, 78, 138

R

Rated operating capacity • 35, 37, 45

Recommended charging levels • 103

Regulatory information • 38

Relays • 134

Releasing the residual pressure of hydraulic system • 93

Replacing battery pack • 20, 135

Requirements for attachments • 87

Reset service reminder • 132

Reverse buzzer (option) • 69

S

Safe stopping procedure • 79

Safety First • 9

Safety frame (ROPS) and safety canopy (FOPS) • 17

Safety instructions • 112

Safety of digging • 18

Seat - Seat belt and seat adjustments • 70

Seat adjustments • 70

Seat belt • 12

Service and maintenance • 10, 112

Service the hydraulic attachment locking (option) • 131

Signs and decals • 27

Smooth drive (option) • 52, 65

Snow chains • 40

Starting the loader • 77

Steering of the loader • 84

Stopping the loader (Safe stopping procedure) • 79, 85

Storage • 99

Storage and transport of battery • 100

Storage, Transport, Tie down points and Lifting • 10, 96

Suspension seat • 70

Switches and indicator lights • 51, 53

Switches on the panel • 51, 52

T

Technical specifications • 36

Telescopic boom control lever • 60

Test drive control and steering • 126

Test parking brake • 126

Test the movements of boom • 126

Tie down options • 98

Tie down points • 96

Tipping load - Load diagram • 48

Tips to increase battery life • 83, 103

To keep the battery in good condition • 104

To start the loader • 78

Towing (retrieval of the machine) • 101
Trailer coupling (option) • 68
Transport cover • 97
Transport on trailer • 97
Troubleshooting • 138
Type 2 charging • 107
Tyres • 38

U

Using the auxiliary hydraulics • 92

W

Warning beacon (option) • 52, 72
Warnings and symbols on the display • 55
Wheel spacer kit • 40
Windscreen washer and wiper (Cab L) • 52, 74
Windscreen washer tank (Cab L) • 74
Work lights • 71
Working near powerlines • 18
Working with attachments • 87

X

X-lock (Cross-lock) and anti-slip • 53, 82



e513/e527

EN

EC DECLARATION OF CONFORMITY

Manufacturer:

Avant Tecno Oy
Ylötie 1, 33470 Ylöjärvi, Finland

Technical Construction File

Location:

Same as Manufacturer

We hereby declare that the machine detailed in this document conforms to the following EC Directives

2006/42/EC (Machinery)

Conformity Assessment Procedure
Self-certification

2014/30/EC (EMC)

Conformity Assessment Procedure
Self-certification

2000/14/EC (Noise Emission)

Conformity Assessment Procedure
Type-test
Eurofins Expert Services Oy
PL 47, 02151 Espoo, Finland

Sound Power Level

Guaranteed **87 dB(A)**

Measured **87 dB(A)**

Jani Käkälä
Managing Director
12.02.2024 Ylöjärvi, Finland

Original language



AVANT[®]

Avant Tecno Oy

Ylötie 1

FIN-33470 YLÖJÄRVI, FINLAND

Tel. +358 3 347 8800

e-mail: sales@avanttecno.com

AVANT has a policy of continuous development, and retains the right to change specifications without notice.

© 2024 Avant Tecno Oy. All rights reserved.

www.avanttecno.com