

KOMATSU

PW98MR-10

MIDI-EXCAVATOR

PW98



ENGINE POWER

50,7 kW / 68 HP @ 1.950 rpm

OPERATING WEIGHT

9.800 - 10.500 kg

BUCKET CAPACITY

max. 0,282 m³

Walk-Around



PW98MR-10

ENGINE POWER

50,7 kW / 68 HP @ 1.950 rpm

OPERATING WEIGHT

9.800 - 10.500 kg

BUCKET CAPACITY

max. 0,282 m³



EXCEPTIONAL PERFORMANCE IN TIGHT SPACES

Powerful and Environmentally Friendly

- Low consumption EU Stage IIIB engine
- Komatsu fuel-saving technology
- Auto-deceleration and eco-gauge
- 6 working modes

Outstanding Performances

- Fast and precise movements
- Wide working range
- Unrivalled controllability
- Excellent mobility in confined work spaces
- Protrusion over tyres just 310 mm

First-Class Comfort

- Spacious and comfortable cab
- ROPS (ISO 12117) - OPG (ISO 10262) level 1
- Quiet and ergonomic working environment
- Widescreen monitor

Total Versatility

- Compact design
- 4-wheel steering enabling 3 steering modes
- Proportional control on joystick for auxiliary circuits
- Innovative two-piece boom design
- Standard hammer line
- Second auxiliary circuit and hydraulic quick-coupler line (optional)

KOMTRAX™

- Komatsu Wireless Monitoring System
- 3G mobile communications
- Integrated communication antenna
- Increased operational data and reports



Powerful and Environmentally Friendly



Eco-gauge, Eco guidance, idle caution and an adjustable idle shutdown all contribute to further reduce fuel consumption

High productivity and fuel saving

Depending on the load, operators can conveniently choose between 6 working modes designed to match engine speed, pump delivery and system pressure. Priority can be given either to speed, for more productivity, or to fuel consumption for lighter applications.

Performance and ecology

The PW98MR-10 is fitted with an engine that meets EU Stage IIIB regulations. Together with an advanced hydraulic system, this electronically controlled common-rail engine with multi stage injection achieves a superior level of productivity. Drastically reduced NOx emissions and noise levels make this compact excavator perfect for confined areas and urban jobsites.

Excellent travel performance

Wheeled excavators are built to move quickly on and between jobsites. To increase its mobility, the PW98MR-10 features a completely reworked driveline for faster travel and uphill driving speeds. The front oscillating axle, manually lockable through a switch on the dashboard, further increases the performance on slopes.

High lift capacity

Along with its class leading compact size, the PW98MR-10 features an unrivalled lifting performance. The combination of power, convenient dimensions and complete control makes the PW98MR-10 the first choice for heavy duty lifting applications or simple excavating tasks in narrow alleys, road-construction sites and for sewer-construction work.

PW98MR-10

First-Class Comfort

Operator's environment

The PW98MR-10 has a spacious cab designed to absorb shocks and offer maximum protection in case of a roll over. It also gives outstanding comfort to this compact machine, even to the most demanding operator. With a double slide mechanism, the seat and PPC levers can be conveniently adjusted for maximum productivity and minimum fatigue. Wide front window - and an opening skylight - enable better visibility in any situation. The standard automatic air conditioner completes a comfortable work environment by maintaining a perfect temperature in the cab, no matter the weather outside.

Large multifunction LCD monitor

A large and user-friendly colour monitor makes working in a PW98MR-10 safe, accurate and smooth. Multilingual and with all essential information available at a glance, it features simple and easy-to-operate switches and multifunction keys that provide the operator with fingertip access to a wide range of functions and operating information.



Easy access with low mounted door handle



Wide glass surface for excellent all around visibility



Large multi-lingual monitor

Total Versatility

Easy operation

The PW98MR-10 introduces a new operational concept that puts full control of the machine right at the operator's fingertips. A rear-view camera, undercarriage attachments and the manual axle lock can all be actuated by buttons on top of the operational levers. Without removing the hand from the right joystick, the operator can switch its function from boom operation to undercarriage control for complete and precise control over the parallel dozer blade.

Work in tight spaces

The short-tail PW98MR-10 delivers optimal power and digging speed, even in confined spaces where traditional machines can't work: yards, road works, demolition sites, sewers, etc. Sturdy and very stable, it guarantees maximum safety and offers complete operator confidence in any working conditions.

4-wheel steering

It's possible to select between 3 steering modes: 2-wheel steering (for travelling), 4-wheel steering (for fast, agile operation) and crab (for confined areas). This ensures outstanding versatility and manoeuvrability. It's easy and safe to change the steering mode: just push a switch. When working, the front-axle oscillation can be blocked for improved stability in 3 different ways: by pushing over the limit the break pedal, by pushing a switch on the PPC or on the right dashboard.



4-wheel steering



Convenient, ergonomic and precise control



Ergonomically designed switches

PW98MR-10

Easy Maintenance



Excellent serviceability

Komatsu designed the PW98MR-10 with an easy access to all service points. Routine maintenance and servicing are less likely to be skipped, which can mean a reduction of costly downtime later on. The radiator, aftercooler and oil cooler are made of aluminium to improve their efficiency and are mounted in parallel for quicker cleaning. The fuel and oil filters as well as the fuel drain valve, are all remote mounted and easily accessible.

EMMS (Equipment Management and Monitoring System)

Komatsu's EMMS can prevent a small problem from becoming a major service issue. The controller monitors all critical systems and key engine features such as engine oil pressure, coolant temperature, battery charge, air clogging etc. If an abnormality occurs, it is displayed on the LCD. The monitor also indicates when the oil or the filters must be replaced.



All major maintenance points can be easily reached from ground level



Fuel pre-filter with water separator

Maintenance	Interval	Reset
Air Cleaner Cleaning or Change	—	—
Coolant Change	—	—
Fuel Pre-filter Change	500 h	500 h
Engine Oil Change	500 h	500 h
Engine Oil Filter Change	500 h	500 h

The LCD monitor informs about abnormalities and replacement times

Information & Communication Technology



Lower operating costs

Komatsu ICT contributes to the reduction of operating costs by assisting to comfortably and efficiently manage operations. It raises the level of customer satisfaction and the competitive edge of our products.

Widescreen monitor

Multilingual and with all essential information available at a glance, it features simple and easy-to-operate switches and multifunction keys that provide the operator with fingertip access to a wide range of functions and operating information.

An evolutionary interface

Helpful information is now easier than ever to find and understand with the upgraded monitor interface. An optimal main screen for the ongoing work can be selected simply by pressing the F3 key.



Quick view on the operation logs



All information at a glance

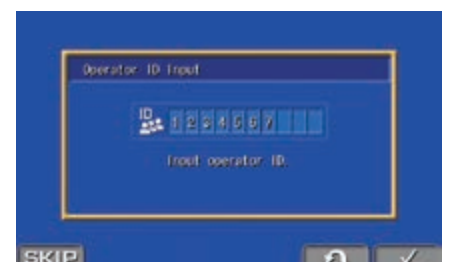

Operator identification function

KOMTRAX™

The way to higher productivity

KOMTRAX™ uses the latest wireless monitoring technology. Compatible on PC, smartphone or tablet, it delivers insightful and cost saving information about your fleet and equipment, and offers a wealth of information to facilitate peak machine performance. By creating a tightly integrated web of support it allows proactive and preventive maintenance and helps to efficiently run a business.



Knowledge

You get quick answers to basic and critical questions about your machines – what they're doing, when they did it, where they're located, how they can be used more efficiently and when they need to be serviced. Performance data is relayed by wireless communication technology (Satellite, GPRS or 3G depending on model) from the machine to a computer and to the local Komatsu distributor – who's readily available for expert analysis and feedback.

Power

The detailed information that KOMTRAX™ puts at your fingertips 24 hours a day, 7 days a week gives the power to make better daily and long-term strategic decisions – at no extra cost. Problems can be anticipated, maintenance schedules customised, downtime minimised and machines kept where they belong: working on the jobsite.

Convenience

KOMTRAX™ enables convenient fleet management on the web, wherever you are. Data is analysed and packaged specifically for effortless and intuitive viewing in maps, lists, graphs and charts. You can foresee eventual maintenance issues and required spare parts, and troubleshoot a problem before Komatsu technicians arrive on site.



Specifications

ENGINE

Model	Komatsu SAA4D95LE-6
Type	Common rail direct injection, water-cooled, emissionised, turbocharged, after-cooled diesel
Engine power	
at rated engine speed	1.950 rpm
ISO 14396	50,7 kW/68 HP
SAE J1349	49,0 kW/65,7 HP
No. of cylinders	4
Bore × stroke	95 mm × 115 mm
Displacement	3.260 cm ³
Max. torque/engine speed	319 Nm/1.400 rpm
Air filter type	Dry, double element type air cleaner with dust indicator and auto-dust evacuator
Fuel	Diesel fuel, conforming to EN590 Class 2/ Grade D. Paraffinic fuel capability (HVO, GTL, BTL), conforming to EN 15940:2016

OPERATING WEIGHT (APPR.)

Operating weight, including 1.650 mm arm, 0,28 m³ bucket (ISO 7451), blade, operator, liquids, filled tank and standard equipment (ISO 6016).

	Width	Operating weight
With rear blade	2.350 mm	10.150 kg
With rear stabilizers	2.330 mm	9.950 kg
With blade and stabilizers	2.350 mm	10.500 kg

TRANSMISSION

Hydrostatic transmission with 4 driving wheels. A travel motor with a creep valve and a gearbox with 2 gear ratio.

Maximum drawbar pull	5.300 daN (5.400 kg)
Max. travel speeds	
Creep / Lo / Hi	4 / 10 / 30 km/h

STEERING

Hydraulically operated steering system that acts on the front and rear wheels by means of double rod hydraulic cylinders in the axles. The operator can select three kinds of steering by means of an electric switch.

Two steering wheels	
Four steering wheels	
Crab steering	
Steering radius	
Two steering wheels	6.450 mm
Four steering wheels	4.040 mm

SERVICE REFILL CAPACITIES

Fuel tank	125 l
Cooling system	10,0 l
Engine oil	11,5 l
Differential (each axle)	9 l
Gearbox	1 l
Swing drive	2,8 l
Hydraulic oil tank	140 l

CAB

Sound-proof cab, provided with safety glasses, liftable windscreen, roof window, sliding door with lock, windscreen-wiper, electric horn, adjustable seat with double slide, control system and instrumentation, adjustable joysticks, outside air inlet.

HYDRAULIC SYSTEM

Type	HydrauMind. Closed-centre system with load sensing and pressure compensation valves
Main pumps	
Pump for	Two-piece boom, arm, bucket, undercarriage, travelling, attachments and pilot circuit
Type	Variable displacement, axial piston
Max. flow	160 l/min
Pump for	Swing
Type	Fixed displacement gear pump
Max. flow	70 l/min
Hydraulic motors	
Travel	1 × piston motor, variable displacement
Swing	1 × piston motor with swing holding brake
Relief valve setting	
Swing	21,1 MPa (215 kg/cm ²)
Travel and work equipment	26,5 MPa (270 kg/cm ²)
Bucket breakout force (ISO 6015)	6.130 daN (6.250 kgf)
Arm crowd force, 1.650 mm arm (ISO 6015)	4.150 daN (4.230 kgf)

SWING SYSTEM

Driven by	Hydraulic motor
Swing reduction gear	Planetary gear
Swing circle lubrication	Grease-bathed
Swing brakes	Automatic, with oil immersed disks
Swing speed	10,0 rpm

BRAKES

Type	Hydraulically controlled, with pedal, by means of two double circuit pumps, acting on oil immersed multiple discs on the four wheels
Service brakes	Hydraulically controlled by means of a pedal, acting on the four wheels
Parking brake	Negative type brakes, hydraulically controlled by means of an electric push button positioned inside the cab, acting on the rear axle

AXLES

Driving and steering axles with epicyclic reduction gears in the hubs. The oscillation of the front axle can be blocked by means of two hydraulic pistons.

Tyres	
Twin tyres (standard)	8.25 - 20
Single tyres (option)	500 / 45-20

ENVIRONMENT

Engine emissions	Fully complies with EU Stage IIIB exhaust emission regulations
Noise levels	
LwA external	99 dB(A) (2000/14/EC Stage II)
LpA operator ear	71 dB(A) (ISO 6396 dynamic test)
Vibration levels (EN 12096:1997)	
Hand/arm	≤ 2,5 m/s ² (uncertainty K = 0,58 m/s ²)
Body	≤ 0,5 m/s ² (uncertainty K = 0,22 m/s ²)
Contains fluorinated greenhouse gas HFC-134a (GWP 1430). Quantity of gas 0,7 kg, CO ₂ equivalent 1,0 t	

Dimensions & Performance Figures

LIFTING CAPACITY

A – Reach from swing centre

B – Height at bucket pin

 – Rating over front









 – Rating over side

Data and specifications are referring to the machine according to 89/392/CE and EN 474-5 directives.









When removing bucket, linkage or cylinder, lifting capacities can be increased by their respective weights.

Lifting capacities with 650 mm bucket (185 kg), twin tyres (8.25-20), blade, levers and cylinder.









WITH BLADE AND OUTRIGGERS UP

B \ A	A	Max.		6,0 m		5,0 m		4,0 m	
									
Arm length 1.650 mm	4,5 m	1.150	750	1.220	810	*1.550	1.200	*1.720	*1.720
	3,0 m	970	620	1.200	790	1.650	1.110	*2.370	1.610
	1,5 m	940	590	1.140	740	1.540	1.010	–	–
	0,0 m	1.020	660	1.130	720	1.490	960	2.110	1.350
	-1,5 m	*1290	860	–	–	1.530	1.000	2.170	1.400
Arm length 1.900 mm	4,5 m	1.070	690	1.240	830	*1.460	1.220	*1.580	*1.580
	3,0 m	910	580	1.200	790	1.670	1.120	*2.230	1.650
	1,5 m	880	550	1.140	740	1.540	1.010	–	–
	0,0 m	950	600	1.110	710	1.470	940	2.090	1.330
	-1,5 m	1.190	770	–	–	1.500	960	2.130	1.360

WITH FRONT BLADE AND OUTRIGGERS DOWN

B \ A	A	Max.		6,0 m		5,0 m		4,0 m	
									
Arm length 1.650 mm	4,5 m	1.570	1.110	1.540	1.180	1.600	1.600	1.760	1.760
	3,0 m	1.520	940	1.620	1.160	1.890	1.590	2.430	2.300
	1,5 m	1.500	910	1.760	1.110	2.220	1.480	–	–
	0,0 m	1.470	990	1.740	1.090	2.290	1.430	3.140	2.020
	-1,5 m	1.330	1.270	–	–	1.900	1.470	2.620	2.070
Arm length 1.900 mm	4,5 m	*1.470	1.030	*1.440	1.200	*1.500	*1.500	*1.620	*1.620
	3,0 m	*1.400	880	*1.550	1.160	*1.810	1.610	*2.290	*2.290
	1,5 m	*1.420	850	*1.720	1.100	*2.160	1.480	–	–
	0,0 m	*1.390	920	*1.750	1.070	*2.290	1.420	*3.140	2.000
	-1,5 m	*1.280	1.150	–	–	*1.990	1.440	*2.730	2.030

WITH FRONT AND REAR OUTRIGGERS DOWN

B \ A	A	Max.		6,0 m		5,0 m		4,0 m	
									
Arm length 1.650 mm	4,5 m	*1.570	10.70	*1.540	1.140	*1.600	*1.600	*1.760	*1.760
	3,0 m	*1.520	910	*1.620	1.110	*1.890	1.540	*2.430	2.230
	1,5 m	*1.500	870	*1.760	1.060	*2.220	1.430	–	–
	0,0 m	*1.470	950	*1.740	1.050	*2.290	1.380	*3.140	1.950
	-1,5 m	*1.330	1.220	–	–	*1.900	1.420	*2.620	2.000
Arm length 1.900 mm	4,5 m	*1.470	990	*1.440	1.160	*1.500	*1.500	*1.620	*1.620
	3,0 m	*1.400	850	*1.550	1.120	*1.810	1.550	*2.290	2.260
	1,5 m	*1.420	810	*1.720	1.060	*2.160	1.430	–	–
	0,0 m	*1.390	880	*1.750	1.030	*2.290	1.370	*3.140	1.920
	-1,5 m	*1.280	1.110	–	–	*1.990	1.390	*2.730	1.960

NOTE:

Ratings are based on ISO standard 10567. Rated loads do not exceed 87% of hydraulic lift capacity or 75% of tipping load. Excavators used in object handling operations must comply with the related local regulations and must be equipped with hose burst valves (boom & arm) and an overload warning device in compliance with EN474-5.

- The values marked with an asterisk (*) are limited by the hydraulic capacities

- Calculations are based on the machine resting on a uniform and firm surface

- The lifting point is a hypothetical hook placed behind the bucket.

WORKING RANGE

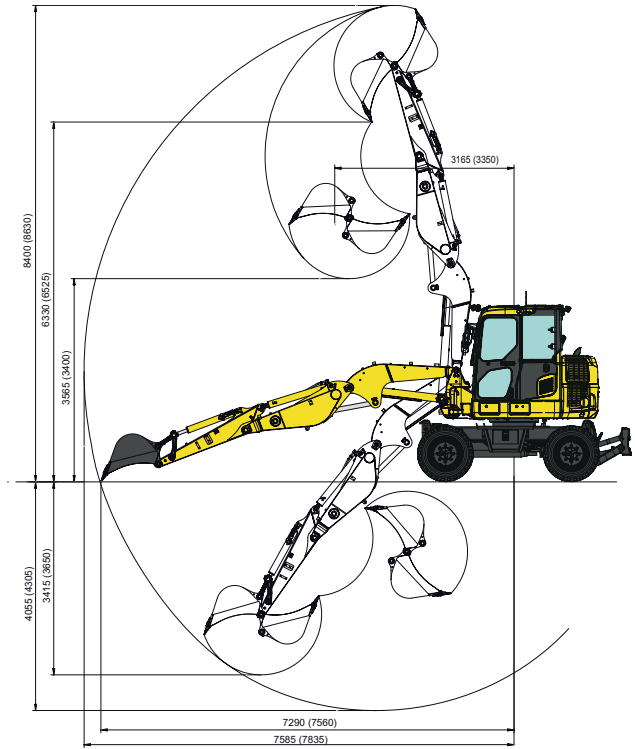

DIMENSIONS

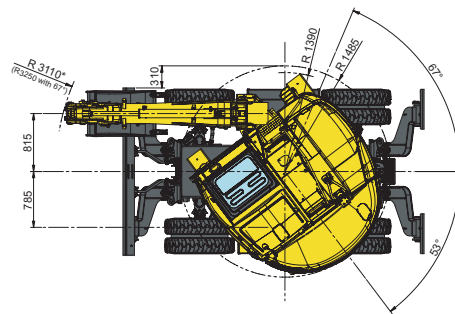

* with 1.900 mm arm

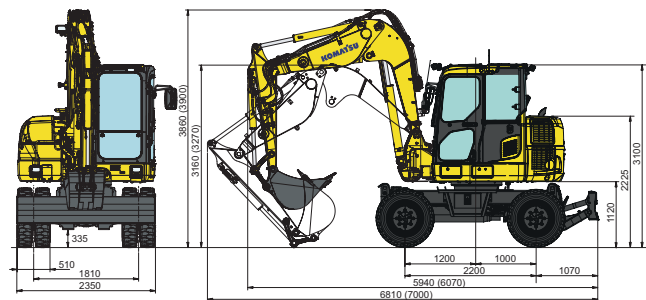

Bucket capacity (ISO 7451)

m³

0,107

0,171

0,181

0,235

0,282

Bucket width (with cutting edge)

mm

350

450

550

650

750

Standard and Optional Equipment

ENGINE

Komatsu SAA4D95LE-6 turbocharged common rail direct injection diesel engine	●
EU Stage IIIB compliant	●
Suction type cooling fan with radiator fly screen	●
Automatic engine warm-up system	●
Engine overheat prevention system	●
Fuel control dial	●
Auto-deceleration function	●
Adjustable idle shutdown	●
Engine key stop	●
Engine ignition can be password secured on request	●
Alternator 24 V/60 A	●
Starter motor 24 V/4,5 kW	●
Batteries 2 × 12 V/75 Ah	●

HYDRAULIC SYSTEM

Electronic closed-centre load sensing (E-CLSS) hydraulic system (HydrauMind)	●
6-working mode selection system; power mode, economy mode, breaker mode, attachment power and attachment economy mode, and lifting mode	●
Adjustable PPC wrist control levers for arm, boom, bucket and swing, with sliding proportional control for attachments and 5 auxiliary buttons, with FNR switch	●
One additional 2-way full-flow service valve with hydraulic line for attachment on boom and arm (HCU-A)	●
Additional auxiliary hydraulic circuit (HCU-B)	●
Relieve valve on service spool	●
2nd auxiliary hydraulic circuit (HCU-C) + preparation for hydraulic quick-coupler	○

SERVICE AND MAINTENANCE

Automatic fuel line de-aeration	●
Double element type air cleaner with dust indicator and auto dust evacuator	●
KOMTRAX™ – Komatsu wireless monitoring system (3G)	●
Multifunction video compatible colour monitor with Equipment Management and Monitoring System (EMMS) and efficiency guidance	●
Toolkit	●

CABIN

Large roof window, pull-up type front window with locking device, removable lower window, front window wiper with intermittent feature, cigarette lighter, floor mat	●
Suspended seat with adjustable arm rests, and retractable seat belt	●
Control lever with FNR switch	●
Automatic climate control system	●
24 Volt power supply	●
Beverage holder	●
Radio pre-setting	●
Radio with Bluetooth	○
Rain visor	○
2 × 12 Volt power supply	○

LIGHTING SYSTEM

Working light on boom	●
Rear working light on cab	○
1 front working light on cab (halogen or LED)	○
4 front working lights on cab (halogen or LED)	○
Additional working light on boom	○

SAFETY EQUIPMENT

Electric horn	●
Overload warning device	●
Audible travel alarm	●
Boom safety valves	●
Large handrails, rear-view mirrors	●
Battery main switch	●
ROPS (ISO 12117) - OPG (ISO 10262) level 1	●
Emergency engine stop switch	●
Seat belt caution indicator	●
Neutral position detection system	●
Arm safety valve	●
Lateral mirror (right side)	●
OPG Level 2 top guard	○
Rotating beacon	○
Rear-view camera system	○
Audible travel alarm (white noise version)	○

UNDERCARRIAGE

Twin tyres 8.25-20	●
Single tyres 500 / 45-20	○
Front blade and rear outriggers	○
Parallel blade (front or rear)	○
2 or 4 outriggers, individually adjustable	○
Fenders	○

DRIVES AND BRAKES

Hydrostatic, 3-speed travel system, hydraulic service and parking brakes	●
Oscillating front axle (± 6°) with automatic and manual cylinder locking	●
Cruise control	●
20, 25 and 30 km/h speed limitation	○

WORK EQUIPMENT

Two-piece boom with cylinder protection	●
1.650 mm arm	●
1.900 mm arm	○
Bucket range (350 - 750 mm)	○
1.500 mm ditch cleaning bucket	○
1.650 mm ditch digging bucket (52°)	○
Bucket linkage with lifting hook	○

OTHER EQUIPMENT

Standard counterweight	●
Electric refuelling pump with automatic shut-off function	○
Biodegradable oil for hydraulic system	○
Customised paint	○

Further equipment on request

- standard equipment
- optional equipment

Your Komatsu partner:

KOMATSU

**Komatsu Europe
International N.V.**

Mechelsesteenweg 586
B-1800 VILVOORDE (BELGIUM)
Tel. +32-2-255 24 11
Fax +32-2-252 19 81
www.komatsu.eu

WENSS07803 04/2019

KOMATSU is a trademark of Komatsu Ltd. Japan.